



Nagar Yuwak Shikshan Sanstha's

Yeshwantrao Chavan College of Engineering

(An Autonomous Institution affiliated to Rashtrasant Tukadoji Maharaj Nagpur University)

Hingna Road, Wanadongri, Nagpur - 441 110

NAAC Accredited with 'A++' Grade

Ph.: 07104-242919, 242623, 242588

Website : www.ycce.edu E-mail : principal@ycce.edu

Summary of 3.1.2

The institution provides seed money to its teachers for research:

3.1.2.1 Seed money provided by the institution to its teachers for research during the year (INR in lakhs):

Year	2021-2022
(INR In Lacks)	6.3

Supporting Documents

1. Sanction Letters of the seed money for the Proposal
2. Project Documents



Principal
Yeshwantrao Chavan
College of Engineering
Wanadongri Hingna Road,
NAGPUR - 441110

Index-3.1.2

2021-22

Sr. No	Name of Supporting Document	Page Nos.
1.	Sanction Letters of the Seed Money for the Proposal	3-44
2.	Project Documents	45-125

Sanction Letters of the Seed Money for the Proposal

R&D Cell, YCCE

NOTE

2nd March, 2021

Sub: Request for approval of budget for In-house funding schemes

As per discussions policies for two in-house funding schemes have been proposed for approval. The schemes include 1. Innovative Minor Patentable Product Scheme and 2. Innovative Experimental Setup Scheme. It is proposed that the schemes would be launched in two phases, Phase I – March 2021 to Sept. 2021 and Phase II- July 2021 to December 2021. Details of the proposed budget for Phase-I is given below

Phase	Scheme	Budget in Rs. Lakh
Phase I	Innovative Minor Patentable Product Scheme	3.00
	Innovative Experimental Setup Scheme.	3.00

It is requested that the budget proposed for Phase-I of Rs. 6.00 Lakh may please be approved.

A.M. Pande

(Dr. A.M. Pande)

Submitted to Hon. Secretary NYSS, through Principal YCCE

P.K.

may be approved
[Signature]
02-03-21

For NA
[Signature]
03-03-21
G.A.

Magm. - To send approval copy to
Do. A.M. Pande, and
Shri Ravin Singh.

[Signature]
3/03

Note

Subject: Recommendation of Proposal submitted under Innovative Minor Patentable Product Scheme of MGI by Review Committee

With reference to the approval of 3.00 Lakh for Innovative Minor Patentable Product Scheme, the committee of following members was constituted to review the proposal submitted by Faculty.

1. Dr. Manali Kshirsagar
2. Dr. Ujjwala Gawande
3. Dr. Sandip Khedkar

Meeting was conducted for presentation of submitted proposals by faculty on 09 September 2021 at 12.00 PM through Offline Mode. Following are the recommendation by each committee Member

Principal Investigator	Title	Amount	Recommendation by Expert Members (Yes/No/Partially)		
			Dr. Manali Kshirsagar	Dr. Ujjwala Gawande	Dr. Sandip Khedkar
Prof. A. A. Yadav	Utilization of metakaolin and concrete slag in concrete.	30,000/-	Yes	Yes	Yes
Prof. A. S. Lilhare Mr.P. S. Shete Dr. Sumant G Kadwane	Development of Power Factor Correction device for residential load.	11,100/-	Yes	Yes	Yes
Prof. Kuldeep Pande	Automatic Book Collector Bot	16,000/-	Yes	Yes	Yes

From the recommendation of the review committee please approve the following proposals with amount

Sr. No.			Amount Requested
1	Prof. A. A. Yadav, Civil Engineering Dept	Utilization of metakaolin and concrete slag in concrete.	30,000/-
2	Prof. A. S. Lilhare, EL Department	Development of Power Factor Correction device for residential load.	11,100/-
3	Prof. Kuldeep Pande, EE Department	Automatic Book Collector Bot	16,000/-
			57,100/-

It is therefore requested to approve the above mentioned proposals under Innovative Minor Patentable Product Scheme.

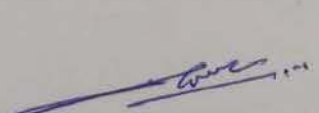
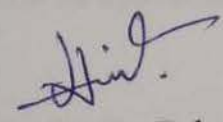

Dr. Sandip Khedkar/Dr. Nita D. Rehpade
Assistant Dean, IPR Vertical

Forwarded for approval

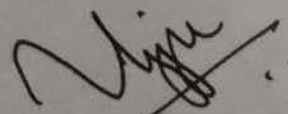
Through,

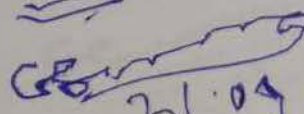
Dr. Ujwala Gawande
Dean, R and D

OK

21.09
Acctt Sect

Encl.

1. Approval of budget for In-house Innovative Minor Patentable Product Scheme

Note

Subject: Recommendation of Proposal submitted under Innovative Minor Patentable Product Scheme of MGI by Review Committee

With reference to the approval of 3.00 Lakh for Innovative Minor Patentable Product Scheme, the committee of following members was constituted to review the proposal submitted by Faculty.

1. Dr. Manali Kahirsagar
2. Dr. Ujjwala Gawande
3. Dr. Nilesh Singh V. Thakur
4. Dr. Sandip Khedkar

Meeting was conducted for presentation of these proposals by faculty on 18th April & 19th April 2022 at 11.00 AM through Offline Mode. Following are the recommendation by each committee Member.

Principal Investigator	Title	Amount	Recommendation by Expert Members (Yes/No/Partially)			
			Dr. Manali Kahirsagar	Dr. Ujjwala Gawande	Dr. Sandip Khedkar	Dr. N. V. Thakur
Dr. B. Y. Masram	Wi-Fi Router with Power Backup and Range Extender	6800/-	Yes	Yes	Yes	Yes
Prof. Y. S. Kale	Development of GSM controller to prevent electricity wastage	10,450/-	Yes	Yes	Yes	Yes
Prof. A. V. Choudhari	Voice based writing Robot	4730/-	Yes	Yes	Yes	Yes
Dr. Sarika Patil	Design and implementation of IOT based SMART inverter	27200/-	Yes	Yes	Yes	Yes
Dr. S. P. Adhau	Plastic Waste Management Machine	22850/-	Yes	Yes	Yes	Yes
Prof. P. S. Patil	Social Distancing Cap	12050/-	Yes	Yes	Yes	Yes
Prof. A. A. Madankar	Automatic Hand Sanitizer machine	1560/-	Yes	Yes	Yes	Yes
Dr. A. D. Belsare	Aerial 3D scanner	30000/-	Yes	Yes	Yes	Yes
Dr. V. D. Bondre	Design and implementation of an ultrasonic navigation stick for the blind *	5730/-	Yes	Yes	Yes	Yes
Prof. M. S. Patil	IOT based Smart Cafeteria Management System	20150/-	Yes	Yes	Yes	Yes
Prof. A. S. Kurzakar	Artificial angular coarse aggregate	4000/-	Yes	Yes	Yes	Yes

Prof. B. S. Sudame	Operation of circuit breaker with authentication	9315/-	Yes	Yes	Yes	Yes
Prof. S. S. Kewte	Fault detection using closed loop feedback system	6124/-	Yes	Yes	Yes	Yes
Prof. Megha Mendiretla	Biomaterial	24336/-	Yes	Yes	Yes	Yes

From the recommendation of the review committee please approve the following proposals with amount

Sr. No.	Principal Investigator	Title	Amount Requested
1	Dr. B. Y. Masram	Wi-Fi Router with Power Backup and Range Extender	6800/-
2	Prof. Y. S. Kale	Development of GSM controller to prevent electricity wastage	10,450/-
3	Prof. A. V. Choudhari	Voice based writing Robot	4730/-
4	Dr. Sarika Patil	Design and implementation of IOT based SMART inverter	27200/-
5	Dr. S. P. Adhau	Plastic Waste Management Machine	22850/-
6	Prof. P. S. Patil	Social Distancing Cap	12050/-
7	Prof. A. A. Madankar	Automatic Hand Sanitizer machine	1560/-
8	Dr. A. D. Belsare	Aerial 3D scanner	30000/-
9	Dr. V. D. Bondre	Design and implementation of an ultrasonic navigation stick for the blind *	5730/-
10	Prof. M. S. Patil	IOT based Smart Cafeteria Management System	20150/-
11	Prof. A. S. Kurzekar	Artificial angular coarse aggregate	4000/-
12	Prof. B. S. Sudame	Operation of circuit breaker with authentication	9315/-
13	Prof. S. S. Kewte	Fault detection using closed loop feedback system	6124/-
14	Prof. Megha Mendiretla	Biomaterial	24336/-
TOTAL			185295 /-

It is therefore requested to approve the above mentioned proposals under Innovative experimental set up scheme.

Dr. S. S. Khedkar/Dr. N. D. Rehpade
Assistant Dean, IPR Vertical

Forwarded for approval
Through,

Dr. Ujwala Gawande
Dean, R and D

Yeshwantrao Chavan College of Engineering
Office of Dean Research and Development

Note

Subject: Recommendation of proposals submitted under Innovative Experimental Set Up Scheme of MGI

With reference to the approval of 3.00 Lakh for Innovative Experimental Setup scheme, the committee of following expert members was constituted to review the proposals submitted by faculty

1. Dr. Manali Khirsagar
2. Dr. N. V. Thakur
3. Dr. U. H. Gawande

Meeting was conducted for review of these proposals on 01/04/2022. Following proposals are recommended by committee member.

SN	Name of Faculty	Department	Title of Innovative Experimental Setup	Amount Approved
1.	Mrs. V. N. Mendhe	CE	Centre of gravity Experiment for regular and irregular shapes	5000/-
2.	Dr. P. D. Dorge	ET	Hardware Experimental Setup to Control and Analyze Signals in Cellular Phone	18,500/-
3.	Dr. M. M. Mendiretta (Khurma)	Applied Chemistry	Alternative Synthesis of common drugs under non-conventional conditions	20,000/-
4.	Mr. Rajesh Bhagat	CE	Adsorbent Containing Filter (ACF)	15,500/-
5.	Pallavi Chakole	CE	Treatment of Wastewater By Rotating Biological Contactor	13,000/-
6.	P. S. Shete/ Prasad Joshi	EL	AC power measurement using Arduino	30,000/-
7.	Vijay Khawale/ Atul Lilhare	ME	Study of various characteristics of PV Panel and DC Solar Water Pump	17,100/-
8.	Devendra Shahare	ME	Design and Development of Experimental setup for Fatigue Testing Machine	32,280/-
9.	Dr. Pournima Pande	Applied Chemistry	Corrosion testing with help of Potentiometer	16,000/-
10.	Dr. Sunil Prayagi	ME	Effect of cooling system on PV panel performance	11,000/-
	Total			1,78,380/-

It is therefore requested to approve the above mentioned proposals under Innovative experimental set up scheme.

Dr. Yogita Chitriv
Assistant Dean, Funding Proposal Division

Forwarded for approval

Through,

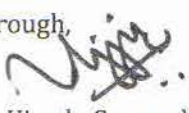
Dr. Ujwala Gawande
Dean, R and D

Encl.

1. Approval of budget for In- house funding schemes

OK

16.04
Acutt Salt

16/04/2022

Note

With reference to the approval of 3.00 Lakh for Innovative Experimental Set up Scheme, the committee of following members was constituted to review the proposal submitted by the faculty.

1. Dr. Milind M. Mushrif, ET Department
2. Prof. Aniket Gokhale, EE Department
3. Dr. S. S. Gokhale, EL Department

Meeting was conducted for presentation of these proposals by faculty on 27 July 2021 at 1.00 PM through Online Mode.

From the recommendation of the review committee, following proposals are approved.

Sr. No.			Amount Requested
1	Dr. U. S. Ghodeswar, EE Department	Wireless Communication using Zigbee	10,000/-
2	Dr. P. P. Zode, EE Department	Long Range Wireless Communication Setup	40,800/-
3	Prof. Atul Lihare, EL Department	Installation of automatic UPS system at Home (Demo Model)	11,700/-
			62,500/-

From the recommendation of the review committee please approve the following proposals with amount

Sr. No.			Amount Requested
1	Dr. U. S. Ghodeswar, EE Department	Wireless Communication using Zigbee	10,000/-
2	Dr. P. P. Zode, EE Department	Long Range Wireless Communication Setup	40,800/-
3	Prof. Atul Lilhare, EL Department	Installation of automatic UPS system at Home (Demo Model)	11,700/-
			62,500/-

It is therefore requested to approve the above mentioned proposals under Innovative experimental set up scheme.

Dr. Yogita Chitriv,
Assistant Dean, Funding Proposal Vertical

Forwarded for approval

Through,

Dr. Ujwala Gawande
Dean, R and D

Encl.

1. Approval of budget for In- house funding schemes

Forwarded to Principal Sir for kind approval

DK
07.08
Dean (R&D)



Nagar Yuwak Shikshan Sanstha's

Yeshwantrao Chavan College of Engineering

(An Autonomous Institution affiliated to Rashtrasant Tukadoji Maharaj Nagpur University)

Hingna Road, Wanadongri, Nagpur - 441 110

Ph.: 07104-237919, 234623, 329249, 329250 Fax: 07104-232376, Website: www.ycce.edu

Research and Development Cell

YCCE/R and D Cell/2021-22/

Date: 02/05/2022

To

Dr. B. Y. Masram

Department of Electronics & Telecommunication Engineering

Subject: Approval of Proposal submitted under Innovative Minor Patentable Product Scheme

Dear, Dr. B. Y. Masram

We are pleased to inform you that your proposal titled "Wi-Fi Router with Power Backup and Range Extender." was recommended by committee for approval; the proposal is approved for financial assistance of **Rs. 5300/-** under non-recurring and **Rs.1500/-** recurring expenses, total expenses of **Rs. 6800/-**.

You are requested to initiate the work on the project at the earliest.

Dr. S. S. Khedkar/
Dr. N. D. Rehpade
Assistant Dean,
IPR Vertical

Dr. Ujwala Gawande

Dean, R and D

Dr. U. P. Waghe

Principal
Principal
Yeshwantrao Chavan
College of Engineering
Wanadongri Hingna Road,
NAGPUR-441110

Copy To

- HoD, Department of Electronics & Telecommunication Engineering, YCCE
- A/C Section, YCCE



Yeshwantrao Chavan College of Engineering

(An Autonomous Institution affiliated to Rashtrasant Tukadoji Maharaj Nagpur University)

Hingna Road, Wanadongri, Nagpur - 441 110

Ph.: 07104-237919, 234623, 329249, 329250 Fax: 07104-232376, Website: www.ycce.edu

Research and Development Cell

YCCE/R and D Cell/2021-22/

Date: 02/05/2022

To

Prof. Y. S. Kale

Department of Electronics & Telecommunication Engineering

Subject: Approval of Proposal submitted under Innovative Minor Patentable Product Scheme

Dear Prof. Y.S. Kale,

We are pleased to inform you that your proposal titled "**Development of GSM controller to prevent electricity wastage.**" was recommended by committee for approval, the proposal is approved for financial assistance of **Rs. 9,450/-** under nonrecurring and **Rs.1,000/-** under recurring expenses, total **Rs. 10,450/-**.

You are requested to initiate the work on the project at the earliest.

Dr. S. S. Khedkar/
Dr. N. D. Rehpade
Assistant Dean,
IPR Vertical

Dr. Ujwalla Gawande
Dean, R and D

Dr. U. P. Waghe

Principal
Yeshwantrao Chavan
College of Engineering
Wanadongri Hingna Road,
NAGPUR-441110

Copy To

- HoD, Department of Electronics & Telecommunication Engineering, YCCE
- A/C Section, YCCE



Nagar Yuwak Shikshan Sanstha's

Yeshwantrao Chavan College of Engineering

(An Autonomous Institution affiliated to Rashtrasant Tukadoji Maharaj Nagpur University)

Hingna Road, Wanadongri, Nagpur - 441 110

Ph.: 07104-237919, 234623, 329249, 329250 Fax: 07104-232376, Website: www.ycce.edu

Research and Development Cell

YCCE/R and D Cell/2021-22/

Date: 02/05/2022

To

Prof. A.V. Choudhari

Department of Electronics & Telecommunication Engineering

Subject: Approval of Proposal submitted under Innovative Minor Patentable Product Scheme

Dear Prof. A.V. Choudhari

We are pleased to inform you that your proposal titled "**Voice based writing Robot**" was recommended by committee for approval, the proposal is approved for financial assistance of **Rs. 3230/-** under/ -non-recurring expenses and **Rs. 1,500/-** under recurring expenses, totaling **Rs. 4730/-**.

You are requested to initiate the work on the project at the earliest.

Dr. S. S. Khedkar/
Dr. N. D. Rehpade
Assistant Dean,
IPR Vertical

Dr. Ujwalla Gawande

Dean, R and D

Dr. U. P. Waghe

Principal
Yeshwantrao Chavan
College of Engineering
Wanadongri Hingna Road,
NAGPUR-441110

Copy To

- HoD, Department of Electronics & Telecommunication Engineering, YCCE
- A/C Section, YCCE



Nagar Yuwak Shikshan Sanstha's
Yeshwantrao Chavan College of Engineering
(An Autonomous Institution affiliated to Rashtrasant Tukadoji Maharaj Nagpur University)
Hingna Road, Wanadongri, Nagpur - 441 110
Ph.: 07104-237919, 234623, 329249, 329250 Fax: 07104-232376, Website: www.ycce.edu

Research and Development Cell

YCCE/R and D Cell/2021-22/

Date: 02/05/2022

To

Dr. Sarika Patil

Department of Electrical Engineering

Subject: Approval of Proposal submitted under Innovative Minor Patentable Product Scheme

Dear Dr. Sarika Patil

We are pleased to inform you that your proposal titled **“Design and implementation of IOT based SMART inverter”** was recommended by committee for approval, the proposal is approved for financial assistance of **Rs. 18200/-** under non-recurring expenses and **Rs. 9000/-** under recurring expenses, totaling **Rs. 27,200/-**.

You are requested to initiate the work on the project at the earliest.

Dr. S. S. Khedkar/
Dr. N. D. Rehpade
Assistant Dean,
IPR Vertical

Dr. Ujwalla Gawande
Dean, R and D

Dr. U. P. Waghe
Principal

Copy To

- HoD, Department of Electrical Engineering, YCCE
- A/C Section, YCCE



Research and Development Cell

YCCE/R and D Cell/2021-22/

Date: 02/05/2022

To,

Dr. S. P. Adhau

Department of Electrical Engineering

Subject: Approval of Proposal submitted under Innovative Minor Patentable Product Scheme

Dear Dr. S. P. Adhau

We are pleased to inform you that your proposal titled **"Plastic Waste Management Machine"** was recommended by committee for approval, the proposal is approved for financial assistance of **Rs. 14850/-** under/ -non-recurring expenses and **Rs. 8000/-** under recurring expenses, totaling **Rs. 22850/-**.

You are requested to initiate the work on the project at the earliest.

Dr. S. S. Khedkar/
Dr. N. D. Rehpade
Assistant Dean,
IPR Vertical

Dr. Ujwalla Gawande
Dean, R and D

Dr. U. P. Waghe
Principal
Yeshwantrao Chavan
College of Engineering
Wanadongri Hingna Road,
NAGPUR-441110

Copy To

- HoD, Department of Electrical Engineering, YCCE
- A/C Section, YCCE



Nagar Yuwak Shikshan Sanstha's

Yeshwantrao Chavan College of Engineering

(An Autonomous Institution affiliated to Rashtrasant Tukadoji Maharaj Nagpur University)

Hingna Road, Wanadongri, Nagpur - 441 110

Ph.: 07104-237919, 234623, 329249, 329250 Fax: 07104-232376, Website: www.ycce.edu

Research and Development Cell

YCCE/R and D Cell/2021-22/

Date: 02/05/2022

To,

Prof. P. S. Patil

Department of Electrical Engineering

Subject: Approval of Proposal submitted under Innovative Minor Patentable Product Scheme

Dear Prof. P. S. Patil

We are pleased to inform you that your proposal titled "**Social Distancing Cap**" was recommended by committee for approval, the proposal is approved for financial assistance of **Rs. 9550/-** under non-recurring expenses and **Rs. 2500/-** under recurring expenses, totaling **Rs. 12050/-**.

You are requested to initiate the work on the project at the earliest.

Dr. S. S. Khedkar/
Dr. N. D. Rehpade
Assistant Dean,
IPR Vertical

Dr. Ujwalla Gawande
Dean, R and D

Dr. U. P. Waghe
Principal
Yeshwantrao Chavan
College of Engineering
Wanadongri Hingna Road,
NAGPUR-441110

Copy To

- HoD, Department of Electrical Engineering, YCCE
- A/C Section, YCCE



Nagar Yuwak Shikshan Sanstha's

Yeshwantrao Chavan College of Engineering

(An Autonomous Institution affiliated to Rashtrasant Tukadoji Maharaj Nagpur University)

Hingna Road, Wanadongri, Nagpur - 441 110

Ph.: 07104-237919, 234623, 329249, 329250 Fax: 07104-232376, Website: www.ycce.edu

Research and Development Cell

YCCE/R and D Cell/2021-22/

Date: 02/05/2022

To

Prof. A. A. Madankar

Department of Electronics & Telecommunication Engineering

Subject: Approval of Proposal submitted under Innovative Minor Patentable Product Scheme

Dear, Prof. A. A. Madankar

We are pleased to inform you that your proposal titled "**Automatic Hand Sanitizer machine**" was recommended by committee for approval; the proposal is approved for financial assistance of **Rs. 560/-** under non-recurring and **Rs. 1000/-** recurring expenses, total expenses of **Rs. 1560/-**.

You are requested to initiate the work on the project at the earliest.

Dr. S. S. Khedkar/
Dr. N. D. Rehpade
Assistant Dean,
IPR Vertical

Dr. Ujwalla Gawande
Dean, R and D

Dr. U. P. Waghe
Principal
Yeshwantrao Chavan
College of Engineering
Wanadongri Hingna Road,
NAGPUR-441110

Copy To

- HoD, Department of Electronics & Telecommunication Engineering, YCCE
- A/C Section, YCCE



Nagar Yuwak Shikshan Sanstha's
Yeshwantrao Chavan College of Engineering

(An Autonomous Institution affiliated to Rashtrasant Tukadoji Maharaj Nagpur University)

Hingna Road, Wanadongri, Nagpur - 441 110

Ph.: 07104-237919, 234623, 329249, 329250 Fax: 07104-232376, Website: www.ycce.edu

Research and Development Cell

YCCE/R and D Cell/2021-22/

Date: 02/05/2022

To

Dr. A. D. Belsare

Department of Electronics & Telecommunication Engineering

Subject: Approval of Proposal submitted under Innovative Minor Patentable Product Scheme

Dear , Dr. A. D. Belsare

We are pleased to inform you that your proposal titled "**Aerial 3D scanner**" was recommended by committee for approval; the proposal is approved for financial assistance of **Rs. 29000/-** under non-recurring and **Rs. 1000/-** recurring expenses, total expenses of **Rs. 30000/-**.

You are requested to initiate the work on the project at the earliest.

Dr. S. S. Khedkar/
Dr. N. D. Rehpade
Assistant Dean,
IPR Vertical

Dr. Ujwalla Gawande

Dean, R and D

Dr. U. P. Waghe

Principal
Yeshwantrao Chavan
College of Engineering
Wanadongri Hingna Road,
NAGPUR-441110

Copy To

- HoD, Department of Electronics & Telecommunication Engineering, YCCE
- A/C Section, YCCE



Nagar Yuwak Shikshan Sanstha's
Yeshwantrao Chavan College of Engineering

(An Autonomous Institution affiliated to Rashtrasant Tukadoji Maharaj Nagpur University)

Hingna Road, Wanadongri, Nagpur - 441 110

Ph.: 07104-237919, 234623, 329249, 329250 Fax: 07104-232376, Website: www.ycce.edu

Research and Development Cell

YCCE/R and D Cell/2021-22/

Date: 02/05/2022

To

Dr. V. D. Bondre

Department of Electronics & Telecommunication Engineering

Subject: Approval of Proposal submitted under Innovative Minor Patentable Product Scheme

Dear , Dr. V. D. Bondre

We are pleased to inform you that your proposal titled **"Design and implementation of an ultrasonic navigation stick for the blind"** was recommended by committee for approval; the proposal is approved for financial assistance of **Rs. 3220/-** under non-recurring and **Rs. 2510/-** recurring expenses, total expenses of **Rs. 5730/-**.

You are requested to initiate the work on the project at the earliest.

Dr. S. S. Khedkar/
Dr. N. D. Rehpade
Assistant Dean,
IPR Vertical

Dr. Ujwalla Gawande
Dean, R and D

Dr. U. P. Waghe
Principal
Yeshwantrao Chavan
College of Engineering
Wanadongri Hingna Road,
NAGPUR-441110

Copy To

- HoD, Department of Electronics & Telecommunication Engineering, YCCE
- A/C Section, YCCE



Nagar YuwakShikshanSanstha's

YeshwantraoChavanCollege of Engineering

(An Autonomous Institution affiliated to Rashtrasant Tukadoji Maharaj Nagpur University)

Hingna Road, Wanadongri, Nagpur - 441 110

Ph.: 07104-237919, 234623, 329249, 329250 Fax: 07104-232376, Website: www.ycce.edu

Research and Development Cell

YCCE/R and D Cell/2021-22/

Date: 02/05/2022

To

Prof. M. S. Patil,

Department of Electronics & Telecommunication Engineering

Subject: Approval of Proposal submitted under Innovative Minor Patentable Product Scheme

Dear, Prof. M. S. Patil,

We are pleased to inform you that your proposal titled **"IOT based Smart Cafeteria Management System"** was recommended by committee for approval; the proposal is approved for financial assistance of **Rs.13,150/-** under non-recurring and **Rs.7,000/-** recurring expenses, total expenses **of Rs. 20,150/-**.

You are requested to initiate the work on the project at the earliest.

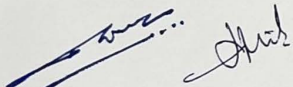
Dr. S. S. Khedkar/
Dr. N. D. Rehpade
Assistant Dean,
Funding Proposal

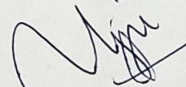
Dr. Ujwala Gawande
Dean, R and D

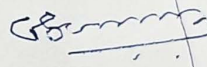
Dr. U. P. Waghe
Principal

Copy To

- HoD, Department of Electronics & Telecommunication Engineering, YCCE
- A/C Section, YCCE



Nagar Yuwak Shikshan Sanstha's
Yeshwantrao Chavan College of Engineering

(An Autonomous Institution affiliated to Rashtrasant Tukadoji Maharaj Nagpur University)

Hingna Road, Wanadongri, Nagpur - 441 110

Ph.: 07104-237919, 234623, 329249, 329250 Fax: 07104-232376, Website: www.ycce.edu

Research and Development Cell

YCCE/R and D Cell/2021-22/

Date: 02/05/2022

To

Prof. A. S. Kurzekar,
Department of Civil Engineering

Subject: Approval of Proposal submitted under Innovative Minor Patentable Product Scheme

Dear, Prof. A. S. Kurzekar

We are pleased to inform you that your proposal titled "**Artificial angular coarse aggregate**" was recommended by committee for approval; the proposal is approved for financial assistance of **Rs. 2000/-** under non-recurring and **Rs. 2000/-** recurring expenses, total expenses of **Rs. 4000/-**.

You are requested to initiate the work on the project at the earliest.

Dr. S. S. Khedkar/
Dr. N. D. Rehpade
Assistant Dean,
IPR Vertical

Dr. Ujwalla Gawande
Dean, R and D

Dr. U. P. Waghe
Principal
Yeshwantrao Chavan
College of Engineering
Wanadongri Hingna Road,
NAGPUR-441110

Copy To

- HoD, Department of Civil Engineering, YCCE
- A/C Section, YCCE



Nagar Yuwak Shikshan Sanstha's
Yeshwantrao Chavan College of Engineering

(An Autonomous Institution affiliated to Rashtrasant Tukadoji Maharaj Nagpur University)

Hingna Road, Wanadongri, Nagpur - 441 110

Ph.: 07104-237919, 234623, 329249, 329250 Fax: 07104-232376, Website: www.ycce.edu

Research and Development Cell

YCCE/R and D Cell/2021-22/

Date: 02/05/2022

To,

Prof. B. S. Sudame

Department of Electrical Engineering

Subject: Approval of Proposal submitted under Innovative Minor Patentable Product Scheme

Dear Prof. B. S. Sudame

We are pleased to inform you that your proposal titled **“Operation of circuit breaker with authentication”** was recommended by committee for approval, the proposal is approved for financial assistance of **Rs. 6315** under non-recurring expenses and **Rs. 3000/-** under recurring expenses, totaling **Rs. 9315/-**.

You are requested to initiate the work on the project at the earliest.

Dr. S. S. Khedkar/
Dr. N. D. Rehpade
Assistant Dean,
IPR Vertical

Dr. Ujwala Gawande

Dean, R and D

Dr. U. P. Waghe

Principal
Yeshwantrao Chavan
College of Engineering
Wanadongri Hingna Road,
NAGPUR-441110

Copy To

- HoD, Department of Electrical Engineering, YCCE
- A/C Section, YCCE



Nagar Yuwak Shikshan Sanstha's

Yeshwantrao Chavan College of Engineering

(An Autonomous Institution affiliated to Rashtrasant Tukadoji Maharaj Nagpur University)

Hingna Road, Wanadongri, Nagpur - 441 110

Ph.: 07104-237919, 234623, 329249, 329250 Fax: 07104-232376, Website: www.ycce.edu

Research and Development Cell

YCCE/R and D Cell/2021-22/

Date: 02/05/2022

To,

Prof. S. S. Kewte

Department of Electrical Engineering

Subject: Approval of Proposal submitted under Innovative Minor Patentable Product Scheme

Dear, Prof. S. S. Kewte

We are pleased to inform you that your proposal titled "**Fault Detection using Closed Loop Feedback System**" was recommended by committee for approval; the proposal is approved for financial assistance of **Rs. 4124/-** under non-recurring expenses and **Rs. 2000/-** under recurring expenses, totaling **Rs. 6124/-**.

You are requested to initiate the work on the project at the earliest.

Dr. S. S. Khedkar/
Dr. N. D. Rehpade
Assistant Dean,
IPR Vertical

Dr. Ujwalla Gawande

Dean, R and D

Dr. U. P. Waghe

Principal
Yeshwantrao Chavan
College of Engineering
Wanadongri Hingna Road,
NAGPUR-441110

Copy To

- HoD, Department of Electrical Engineering, YCCE
- A/C Section, YCCE



Nagar Yuwak Shikshan Sanstha's

Yeshwantrao Chavan College of Engineering

(An Autonomous Institution affiliated to Rashtrasant Tukadoji Maharaj Nagpur University)

Hingna Road, Wanadongri, Nagpur - 441 110

Ph.: 07104-237919, 234623, 329249, 329250 Fax: 07104-232376, Website: www.ycce.edu

Research and Development Cell

YCCE/R and D Cell/2021-22/

Date: 02/05/2022

To,
Prof. Megha Mendiretla
Department of Chemistry (FY)

Subject: Approval of Proposal submitted under Innovative Minor Patentable Product Scheme

Dear, Prof. Megha Mendiretla

We are pleased to inform you that your proposal titled "**Biomaterial**" was recommended by committee for approval, the proposal is approved for financial assistance of **Rs. 24336/- under** recurring expenses, totaling **Rs. 24336/-**.

You are requested to initiate the work on the project at the earliest.

Dr. S. S. Khedkar/
Dr. N. D. Rehpade
Assistant Dean,
IPR Vertical

Dr. Ujwala Gawande
Dean, R and D

Dr. U. P. Waghe

Principal
Yeshwantrao Chavan
College of Engineering
Wanadongri Hingna Road,
NAGPUR-441110

Copy To

- HoD, Department of Chemistry (FY), YCCE
- A/C Section, YCCE



Office of Dean Research and Development

YCCE/R and D Cell/2021-22/ 568

Date: 16/04/2022

To

Mrs. V. N. Mendhe

Department of Civil Engineering

Subject: Approval of Proposal submitted under In-House Scheme of Innovative Experimental Research

Dear Mrs. V. N. Mendhe

We are pleased to inform you that your proposal titled "Centre of gravity Experiment for regular and irregular shapes" is recommended by committee for approval, the proposal is approved for financial assistance of **Rs. 5,000.**

You are requested to initiate the work on the project at the earliest.

Dr. Yogita Chitriv
Assistant Dean,
Funding Proposal

Dr. Ujwala Gawande
Dean, R and D

Dr. U. P. Waghe
Principal

Copy To

- HoD, Department of Civil Engineering, YCCE
- A/C Section, YCCE



Nagar Yuwak Shikshan Sanstha's

Yeshwantrao Chavan College of Engineering

(An Autonomous Institution affiliated to Rashtrasant Tukadoji Maharaj Nagpur University)

Hingna Road, Wanadongri, Nagpur - 441 110

Ph.: 07104-237919, 234623, 329249, 329250 Fax: 07104-232376, Website: www.ycce.edu

Office of Dean Research and Development

YCCE/R and D Cell/2021-22/569

Date: 16/04/2022

To

Dr. P. D. Dorge

Department of Electronics and Telecommunication Engineering

Subject: Approval of Proposal submitted under In-House Scheme of Innovative Experimental Research

Dear Dr. P. D. Dorge

We are pleased to inform you that your proposal titled "Hardware Experimental Setup to Control and Analyze Signals in Cellular Phone" is recommended by committee for approval, the proposal is approved for financial assistance of **Rs. 18,500/-**

You are requested to initiate the work on the project at the earliest.

Dr. Yogita Chitriv
Assistant Dean,
Funding Proposal

Dr. Ujwalla Gawande
Dean, R and D

Dr. U. P. Waghe
Principal

Copy To

- HoD, Department of Electronics and Telecommunication Engineering, YCCE
- A/C Section, YCCE



Nagar Yuwak Shikshan Sanstha's

Yeshwantrao Chavan College of Engineering

(An Autonomous Institution affiliated to Rashtrasant Tukadoji Maharaj Nagpur University)

Hingna Road, Wanadongri, Nagpur - 441 110

Ph.: 07104-237919, 234623, 329249, 329250 Fax: 07104-232376, Website: www.ycce.edu

Office of Dean Research and Development

YCCE/R and D Cell/2021-22/570

Date: 16/04/2022

To

Dr. M. M. Mendiretta (Khurma)

Department of Applied Chemistry

Subject: Approval of Proposal submitted under In-House Scheme of Innovative Experimental Research

Dear Dr. M. M. Mendiretta (Khurma)

We are pleased to inform you that your proposal titled "Alternative Synthesis of common drugs under non-conventional conditions" was recommended by committee for approval, the proposal is approved for financial assistance of **Rs. 20,000/-**

You are requested to initiate the work on the project at the earliest.

Dr. Yogita Chitriv
Assistant Dean,
Funding Proposal

Dr. Ujwalla Gawande
Dean, R and D

Dr. U. P. Waghe
Principal

Copy To

- HoD, Department of Applied Chemistry, YCCE
- A/C Section, YCCE



Office of Dean Research and Development

YCCE/R and D Cell/2021-22/ 571

Date: 16/04/2022

To

Mr. Rajesh Bhagat

Department of Civil Engineering

Subject: Approval of Proposal submitted under In-House Scheme of Innovative Experimental Research

Dear Mr. Rajesh Bhagat

We are pleased to inform you that your proposal titled "Adsorbent Containing Filter (ACF)" was recommended by committee for approval, the proposal is approved for financial assistance of **Rs. 15,500/-**

You are requested to initiate the work on the project at the earliest.

Dr. Yogita Chitriv
Assistant Dean,
Funding Proposal

Dr. Ujwalla Gawande
Dean, R and D

Dr. U. P. Waghe
Principal

Copy To

- HoD, Department of Civil Engineering, YCCE
- A/C Section, YCCE



Nagar Yuwak Shikshan Sanstha's

Yeshwantrao Chavan College of Engineering

(An Autonomous Institution affiliated to Rashtrasant Tukadoji Maharaj Nagpur University)

Hingna Road, Wanadongri, Nagpur - 441 110

Ph.: 07104-237919, 234623, 329249, 329250 Fax: 07104-232376, Website: www.ycce.edu

Office of Dean Research and Development

YCCE/R and D Cell/2021-22/ 572

Date: 16/04/2022

To

Pallavi Chakole

Department of Civil Engineering

Subject: Approval of Proposal submitted under In-House Scheme of Innovative Experimental Research

Dear Pallavi Chakole

We are pleased to inform you that your proposal titled "Treatment of Wastewater By Rotating Biological Contactor" is recommended by committee for approval, the proposal is approved for financial assistance of **Rs. 13,000/-**

You are requested to initiate the work on the project at the earliest.

Dr. Yogita Chitriv
Assistant Dean,
Funding Proposal

Dr. Ujwalla Gawande
Dean, R and D

Dr. U. P. Waghe
Principal

Copy To

- HoD, Department of Civil Engineering, YCCE
- A/C Section, YCCE



Nagar Yuwak Shikshan Sanstha's

Yeshwantrao Chavan College of Engineering

(An Autonomous Institution affiliated to Rashtrasant Tukadoji Maharaj Nagpur University)

Hingna Road, Wanadongri, Nagpur - 441 110

Ph.: 07104-237919, 234623, 329249, 329250 Fax: 07104-232376, Website: www.ycce.edu

Office of Dean Research and Development

YCCE/R and D Cell/2021-22/573

Date: 16/04/2022

To

P. S. Shete and Prasad Joshi

Department of Electrical Engineering

Subject: Approval of Proposal submitted under In-House Scheme of Innovative Experimental Research

Dear P. S. Shete and Prasad Joshi

We are pleased to inform you that your proposal titled "AC power measurement using Arduino" is recommended by committee for approval, the proposal is approved for financial assistance of **Rs. 30,000/-**

You are requested to initiate the work on the project at the earliest.

Dr. Yogita Chitriv
Assistant Dean,
Funding Proposal

Dr. Ujwalla Gawande
Dean, R and D

Dr. U. P. Waghe
Principal

Copy To

- HoD, Department of Electrical Engineering, YCCE
- A/C Section, YCCE



Office of Dean Research and Development

YCCE/R and D Cell/2021-22/574

Date: 16/04/2022

To

1. Dr. Vijay Khawale, Department of Mechanical Engineering
2. Atul Lilhare Department of Electrical Engineering

Subject: Approval of Proposal submitted under In-House Scheme of Innovative Experimental Research

Dear Dr. Vijay Khawale and Atul Lilhare

We are pleased to inform you that your proposal titled "Study of various characteristics of PV Panel and DC Solar Water Pump." is recommended by committee for approval, the proposal is approved for financial assistance of **Rs. 17,100/-**

You are requested to initiate the work on the project at the earliest.

Dr. Yogita Chitriv
Assistant Dean,
Funding Proposal

Dr. Ujwalla Gawande
Dean, R and D

Dr. U. P. Waghe
Principal

Copy To

- HoD, Department of Mechanical Engineering, YCCE
- HoD, Department of Electrical Engineering, YCCE
- A/C Section, YCCE



Office of Dean Research and Development

YCCE/R and D Cell/2021-22/ 575

Date: 16/04/2022

To

Devendra Shahare

Department of Mechanical Engineering

Subject: Approval of Proposal submitted under In-House Scheme of Innovative Experimental Research

Dear Devendra Shahare

We are pleased to inform you that your proposal titled "Design and Development of Experimental setup for Fatigue Testing Machine " is recommended by committee for approval, the proposal is approved for financial assistance of **Rs. 32,280/-**

You are requested to initiate the work on the project at the earliest.

Dr. Yogita Chitriv
Assistant Dean,
Funding Proposal

Dr. Ujwala Gawande
Dean, R and D

Dr. U. P. Waghe
Principal

Copy To

- HoD, Department of Mechanical Engineering, YCCE
- A/C Section, YCCE



Office of Dean Research and Development

YCCE/R and D Cell/2021-22/ 576

Date: 16/04/2022

To

Dr. Pournima Pande

Department of Applied Chemistry

Subject: Approval of Proposal submitted under In-House Scheme of Innovative Experimental Research

Dear Dr. Pournima Pande

We are pleased to inform you that your proposal titled "Corrosion testing with help of Potentiometer" is recommended by committee for approval, the proposal is approved for financial assistance of **Rs. 16,000/-**

You are requested to initiate the work on the project at the earliest.

Dr. Yogita Chitriv
Assistant Dean,
Funding Proposal

Dr. Ujwalla Gawande
Dean, R and D

Dr. U. P. Waghe
Principal

Copy To

- HoD, Department of Applied Chemistry, YCCE
- A/C Section, YCCE



Nagar Yuwak Shikshan Sanstha's

Yeshwantrao Chavan College of Engineering

(An Autonomous Institution affiliated to Rashtrasant Tukadoji Maharaj Nagpur University)

Hingna Road, Wanadongri, Nagpur - 441 110

Ph.: 07104-237919, 234623, 329249, 329250 Fax: 07104-232376, Website: www.ycce.edu

Office of Dean Research and Development

YCCE/R and D Cell/2021-22/577

Date: 16/04/2022

To

Dr. Sunil Prayagi

Department of Mechanical Engineering

Subject: Approval of Proposal submitted under In-House Scheme of Innovative Experimental Research

Dear Dr. Sunil Prayagi

We are pleased to inform you that your proposal titled "Effect of cooling system on PV panel performance" is recommended by committee for approval, the proposal is approved for financial assistance of **Rs. 11,000/-**

You are requested to initiate the work on the project at the earliest.

Dr. Yogita Chitriv
Assistant Dean,
Funding Proposal

Dr. Ujwalla Gawande
Dean, R and D

Dr. U. P. Waghe
Principal

Copy To

- HoD, Department of Mechanical Engineering, YCCE
- A/C Section, YCCE



Nagar YuwakShikshanSanstha's
YeshwantraoChavanCollege of Engineering
(An Autonomous Institution affiliated to RashtrasantTukadojiMaharajNagpurUniversity)
Hingna Road, Wanadongri, Nagpur - 441 110
Ph.: 07104-237919, 234623, 329249, 329250 Fax: 07104-232376, Website: www.ycce.edu

Research and Development Cell

YCCE/R and D Cell/2021-22/

Date:31/01/2022

To,

Prof.Akshay Kadu, Prof.Nivedita Padole
Department of Electrical Engineering,
YCCE,Nagpur.

Subject: Approval of Proposal submitted under Minor patentable product Scheme

Dear Prof.AkshayKadu&Prof.NiveditaPadole

We are pleased to inform you that your proposal titled **“Design and implementation of equitable water distribution valve for solar water heater”** was recommended by committee for approval; the proposal is approved for financial assistance of Rs. **6,000/-** under non-recurring expenses and **Rs. 3000/-** under recurring expenses. Total Financial assistance amount of **Rs.9000/-**.

You are requested to initiate the work on the project at the earliest.

Dr. Sandeep Khedkar
Dr. Nita D.Rehpade
Assistant Dean,
IPR Vertical

Dr. UjwallaGawande
Dean, R and D

Dr. U. P. Waghe

Principal
Principal
Yeshwantrao Chavan
College of Engineering
Wanadongri Hingna Road,
NAGPUR-441110

Copy To

- HoD, Department of Electrical Engineering, YCCE
- A/C Section, YCCE



Nagar YuwakShikshanSanstha's

Yeshwantrao Chavan College of Engineering

(An Autonomous Institution affiliated to Rashtrasant Tukadoji Maharaj Nagpur University)

Hingna Road, Wanadongri, Nagpur - 441 110

Ph.: 07104-237919, 234623, 329249, 329250 Fax: 07104-232376, Website: www.ycce.edu

Research and Development Cell

YCCE/R and D Cell/2021-22/

Date: 31/01/2022

To,

Prof. H.R. Nikhade,
Department of Civil Engineering,
YCCE, Nagpur.

Subject: Approval of Proposal submitted under Minor patentable product Scheme

Dear Prof. H.R. Nikhade,

We are pleased to inform you that your proposal titled **"Utilization of Sugar cane bagasse ash in the directional of sustainable development"** was recommended by committee for approval; the proposal is approved for financial assistance of Rs. **30,000/-** under recurring expenses.

You are requested to initiate the work on the project at the earliest.

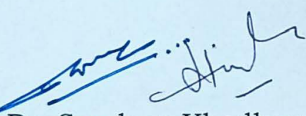
Dr. Sandeep Khedkar
Dr. Nita D. Rehpade
Assistant Dean,
IPR Vertical

Dr. Ujwalla Gawande

Dean, R and D

Dr. U. P. Waghe

Principal
Yeshwantrao Chavan
College of Engineering
Wanadongri Hingna Road,
NAGPUR-441110

Copy To

- HoD, Department of Civil Engineering, YCCE
- A/C Section, YCCE



Research and Development Cell

YCCE/R and D Cell/2021-22/1265

Date: 26/10/2021

To
Dr. Harshal Warade
Department of Civil Engineering

Subject: Approval of Proposal submitted under In-House Scheme of Innovative Experimental Research

Dear Dr. Harshal Warade

We are pleased to inform you that your proposal titled "Treatment of Wastewater by Rotating Biological Contactor" was recommended by committee for approval, the proposal is approved for financial assistance of **Rs. 15,000** under nonrecurring and **3000/-** under recurring expenses, totaling **Rs. 18,000/-**

You are requested to initiate the work on the project at the earliest.

Dr. Yogita Chitri
Assistant Dean,
Funding Proposal

Dr. Ujwala Gawande
Dean, R and D

Dr. U. P. Waghe
Principal

Copy To

- HoD, Department of Civil Engineering, YCCE
- A/C Section, YCCE



Nagar Yuwak Shikshan Sanstha's
Yeshwantrao Chavan College of Engineering

(An Autonomous Institution affiliated to Rashtrasant Tukadoji Maharaj Nagpur University)

Hingna Road, Wanadongri, Nagpur - 441 110

Ph.: 07104-237919, 234623, 329249, 329250 Fax: 07104-232376, Website: www.ycce.edu

Research and Development Cell

YCCE/R and D Cell/2021-22/

Date: 16/09/2021

To

Prof. A. A. Yadav

Department of Civil Engineering

Subject: Approval of Proposal submitted under In-House Innovative Minor Patentable Product Scheme.

Dear Prof. A. A. Yadav

We are pleased to inform you that your proposal titled "Utilization of metakaolin and concrete slag in concrete." was recommended by committee for approval; the proposal is approved for financial assistance of Rs. **30,000/-** under recurring expenses.

You are requested to initiate the work on the project at the earliest.

Dr. Sandip Khedkar/
Dr. Nita D. Rehpade
Assistant Dean,
IPR Vertical

Dr. Ujwalla Gawande
Dean, R and D

Dr. U. P. Waghe
Principal

Copy To

- HoD, Department of Civil Engineering, YCCE
- A/C Section, YCCE



Nagar Yuwak Shikshan Sanstha's

Yashwantrao Chavan College of Engineering

(An Autonomous Institution affiliated to Rashtrasant Tukadoji Maharaj Nagpur University)

Hingna Road, Wanadongri, Nagpur - 441 110

Ph.: 07104-237919, 234623, 329249, 329250 Fax: 07104-232376, Website: www.ycce.edu

Research and Development Cell

YCCE/R and D Cell/2021-22/

Date:16/09/2021

To

Dr. Atul Lilhare

Department of Electrical Engineering

Subject: Approval of Proposal submitted under In-House Innovative Minor Patentable Product Scheme.

Dear Prof. Atul Lilhare

We are pleased to inform you that your proposal titled "Development of Power Factor Correction device for residential load." was recommended by committee for approval, the proposal is approved for financial assistance of **Rs. 6,100/-** under nonrecurring and **5,000/-** under recurring expenses, totaling **Rs. 11,100/-**.

You are requested to initiate the work on the project at the earliest.

Dr. Sandip Khedkar/
Dr. Nita D. Rehpade
Assistant Dean,
IPR Vertical

Dr. Ujwalla Gawande
Dean, R and D

Dr. U. P. Waghe
Principal

Copy To

- HoD, Department of Electrical Engineering, YCCE
- A/C Section, YCCE



Nagar Yuwak Shikshan Sanstha's

Yashwantrao Chavan College of Engineering

(An Autonomous Institution affiliated to Rashtrasant Tukadoji Maharaj Nagpur University)

Hingna Road, Wanadongri, Nagpur - 441 110

Ph.: 07104-237919, 234623, 329249, 329250 Fax: 07104-232376, Website: www.ycce.edu

Research and Development Cell

YCCE/R and D Cell/2021-22/

Date: 16/09/2021

To

Prof. Kuldeep Pande

Department of Electronics Engineering

Subject: Approval of Proposal submitted under In-House Innovative Minor Patentable Product Scheme.

Dear Prof. Kuldeep Pande

We are pleased to inform you that your proposal titled "Automatic Book Collector Bot" was recommended by committee for approval, the proposal is approved for financial assistance of **Rs. 13,500/-** under nonrecurring expenses and **2,500/-** under recurring expenses, totaling **Rs. 16,000/-**.

You are requested to initiate the work on the project at the earliest.

Dr. Sandip Khedkar/
Dr. Nita D. Rehpade
Assistant Dean,
IPR Vertical

Dr. Ujwala Gawande
Dean, R and D

Dr. U. P. Waghe
Principal

Copy To

- HoD, Department of Electronics Engineering, YCCE
- A/C Section, YCCE



Research and Development Cell

YCCE/R and D Cell/2021-22/ 1009

Date: 27/08/2021

To

Dr. Pravin Zode

Department of Electronics Engineering

Subject: Approval of Proposal submitted under In-House Scheme of Innovative Experimental Research

Dear Dr. Pravin Zode

We are pleased to inform you that your proposal titled "Long Range Wireless Communication Setup" was recommended by committee for approval, the proposal is approved for financial assistance of Rs. 37,800 under nonrecurring and 3000/- under recurring expenses, totaling **Rs. 40,800/-**

You are requested to initiate the work on the project at the earliest.

Dr. Yogita Chitriv
Assistant Dean,
Funding Proposal

Dr. Ujwalla Gawande
Dean, R and D

Dr. U. P. Waghe
Principal

Copy To

- HoD, Department of Electronics Engineering, YCCE
- A/C Section, YCCE



Research and Development Cell

YCCE/R and D Cell/2021-22/1010

Date: 27/08/2021

To

Dr. Atul Lilhare

Department of Electrical Engineering

Subject: Approval of Proposal submitted under In-House Scheme of Innovative Experimental Research

Dear Prof. Atul Lilhare

We are pleased to inform you that your proposal titled "Installation of automatic UPS system at Home (Demo Model)" was recommended by committee for approval, the proposal is approved for financial assistance of Rs. 10,700 under nonrecurring and 1000/- under recurring expenses, totaling **Rs. 11,700/-**

You are requested to initiate the work on the project at the earliest.

Dr. Yogita Chitriv
Assistant Dean,
Funding Proposal

Dr. Ujwala Gawande
Dean, R and D

Dr. U. P. Waghe
Principal



Copy To

- HoD, Department of Electrical Engineering, YCCE
- A/C Section, YCCE



Research and Development Cell

YCCE/R and D Cell/2021-22/1011

Date: 27/08/2021

To

Dr. U. S. Ghodeswar

Department of Electronics Engineering

Subject: Approval of Proposal submitted under In-House Scheme of Innovative Experimental Research

Dear Dr. U. S. Ghodeswar

We are pleased to inform you that your proposal titled "Wireless Communication using Zigbee" was recommended by committee for approval, the proposal is approved for financial assistance of **Rs. 10,000** under nonrecurring expenses.

You are requested to initiate the work on the project at the earliest.

Dr. Yogita Chitriv
Assistant Dean,
Funding Proposal

Dr. Ujwalla Gawande
Dean, R and D

Dr. U. P. Waghe
Principal

Copy To

- HoD, Department of Electronics Engineering, YCCE
- A/C Section, YCCE

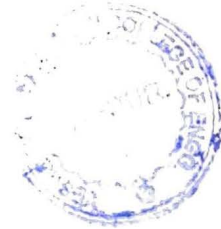

Annexure "A"

Department :- Electronics Engineering

Title of the Project	Name of the Students	Roll No.	Likely Date of Commencement & Completion of Project		Estimates of Project			Total Estim (a)+(b)+(c)	Guide Name
			Commencement	Completion	a) Cost of Major Components (in Rs.)	b) Fabrication Cost (in Rs.)	c) other expences (c)		
Domotics Chair	Chhayangi Sonekar	28	17/07/2021	11/11/2021	7,677	Nil	Nil	7677	Dr. Mrs. S.V.Rathkantiwar
	Siddharth Rao	23							
	Ritik Wankhede	26							
	Uttara Dhoble	43							
	Yashvi Potdukhe	50							
Micro-Camera based Airotor	Sushant Deo	166	22/07/2021	29/11/2021	2,140	Nil	Nil	2140	Dr. Y.A.Suryawanshi
	Himanshi Tekade	3							
	Bhushan Khandekar	143							
	Aishwarya Petkar	27							
	Rutuja Jambhulkar	12							
Implementation of IOT Based Healthcare and saline monitoring sysytem using Arduino UNO	Rinkesh Pantawane	49	20/07/2021	23/11/2021	4,169	Nil	Nil	4169	Dr. R.D.Thakare
	Amlan Jyoti	65							
	Sangeeta Sheoran	17							
	Shivali Sonarkar	18							
	Yogeshwar Uikey	62							
IOT Based Smart Video Doorbell Using ESP32 Camera	Tushita Kaple	123	19/07/2021	6/12/2021	4122	Nil	Nil	4122	Dr. Prasanna Palsodkar
	Mansi Manmode	110							
	Kartik Kinhekar	147							
	Anshul Balpande	138							
	Shreyash Gulhane	155							
Total Amount					18,108			18,108	

Remarks By Head of the Department - Recommended -no of UG Projects :- 04

Total Estimated Cost Rs.18108.00



Signature of Head of the Department

Approved / Not Approved



Principal, YCCE

YESHWANTRAO CHAVAN COLLEGE OF ENGINEERING
APPROVAL FOR PROJECT EXPENSES
 Department of Computer Technology

S.No.	Title of Project	Name of Students	Roll.No.	Likely date of Commencement & completion of project		Estimate of			Total Estimated cost a+b+c	Remark
				Commencement	Completion	a) Cost of Major component/ Software	b) Fabrication Cost	c) Other Expenses		
1	Automated Fire Extinguishing Robot	Devyabi Raut, Indrayani Mundle, Kshiti devgaor	106, 109, 113, 179	01/08/2022	01/06/2022	4615	-	-	4615	Bills are attached
2	Virtual coding Platform	Abhishek Yadav, Akshit Panday, sarthak Chafle, Prathmesh Fulkari	31, 36, 68, 61	01/08/2022	01/06/2022	4408	-	-	4408	Billing account and account ID attached

Mark by H.O.D.

Forwarded for Approval
to R/S Principal sir



 Signature of HOD
 (Approval/ Not Approval)

 Principal

Project Documents

CERTIFICATE OF APPROVAL

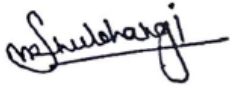
Certified that the project report entitled "DOMOTICS CHAIR" has been successfully completed by CYRUS under the guidance of Dr.Mrs. S.V.Rathkanthiwar of in recognition to the partial fulfilment for the award of the degree of B.E. Electronics Engineering, Yeshwantrao Chavan College of Engineering (An Autonomous Institution Affiliated to Rashtrasant Tukadoji Maharaj Nagpur University), Nagpur during session 2021-22.



Dr.Mrs.S.V.Rathkanthiwar

(Guide)



Dr. P.P.Palsodkar/ Dr. U.S. Ghodeswar

(Project Co-coordinators)

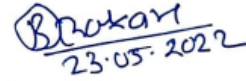

23.05.2022

Dr. R. D. Thakare

(HOD, EE Dept.)



Signature of External Examiner:

Name: Dr R Pethe

Date of Examination: June 1st, 2022

CERTIFICATE OF APPROVAL

Certified that the project report entitled “**Implementation of IoT Based Healthcare and Saline Monitoring System Using Arduino UNO**” has been successfully completed by **RINKESH PANTAWANE, AMLAN JYOTI, SANGEETA SHEORAN, YOGESHWAR UIKEY, and SHIVALI SONARKAR** under the guidance of **Dr. R. D. THAKARE** and **MR. G. S. KANADE (SENIOR PRINCIPAL SCIENTIST) NEERI, NAGPUR** in recognition to the partial fulfillment for the award of the degree of Bachelor of Engineering in **Electronics Engineering, Yeshwantrao Chavan College of Engineering (An Autonomous Institution Affiliated to Rashtrasant Tukadoji Maharaj Nagpur University)**.
Nagpur during session 2021-22



Dr. R. D. Thakare
HOD of EE Dept.
(Guide)



Mr. G. S. Kanade
(Senior Principal Scientist) Neeri, Nagpur
(Co-Guide)



Dr. P.P. Palsodkar / Dr. U.S. Ghodeswar
(Project Coordinators)



Dr. R. D. Thakare
(HOD, EE Dept.)



Signature of External

Examiner Name: *Dr R Pethe*

Date of Examination *31/6/22*

CERTIFICATE OF APPROVAL

Certified that the project report entitled "IoT Based Smart Video Doorbell using ESP32 Camera & Controlling Home Appliances" has been successfully completed by Ms. Tushita R. Kaple, Ms. Mansi R. Manmode, Mr. Anshul R. Balpande, Mr. Kartik V. Kinhekar, Mr. Shreyash R. Gulhane under the guidance of Dr. Prasanna Palsodkar in recognition to the partial fulfillment for the award of the degree of B.E. Electronics Engineering, Yeshwantrao Chavan College of Engineering (An Autonomous Institution Affiliated to Rashtrasant Tukadoji Maharaj Nagpur University), Nagpur during session 2021-22



Dr. Prasanna Palsodkar

(Guide)



Dr. P.P. Palsodkar/ Dr. U.S. Ghodeswar

(Project Cordinators)



Dr. R. D. Thakare

(HOD, EE Dept.)

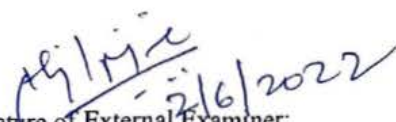

Signature of External Examiner:
Name:
Date of Examination:

CERTIFICATE OF APPROVAL

Certified that the project report entitled "SMART HIGHWAY" has been successfully completed by

ASHA KODAPE

AWANTIKA THAKARE

MITALI DESHPANDE

PRACHI JAMBHULKAR

SAMRUDDHI WARKAD

ATHARV GEDAM

HARDIK THENGRE

PRAGATI MOHANE

Dr. SANDEEP GAIGOWAL

(Project Guide)
(EL Dept.)
YCCE, Nagpur

MRS. NEHA CHANPURKAR

(Project Co-guide)
(Deputy Executive Engineer, MSEDCL,
Nagpur)

Prof. UJWALA WAGHMARE

(Project Co-Ordinator)
YCCE, Nagpur

Dr. S.G. KADWANE

(HOD, EL Dept.)
YCCE, Nagpur

CERTIFICATE OF APPROVAL

Certified that the project report entitled “**Development and Implementation of Solar Assisted Electric Bicycle**” has been efficiently completed by way of underneath the steerage of **Dr. S. P. GAWANDE** in reputation to the partial fulfilment for the award of the diploma of Bachelor of Engineering in Electrical Engineering, **YESHWANTRAO CHAVAN COLLEGE OF ENGINEERING (An Autonomous Institution Affiliated to Rashtrasant Tukdoji Maharaj Nagpur University)**.



Signature

Dr. S. P. Gawande

(Project Guide)



Signature

Prof. Ujwala Waghmare

(Project Coordinator)



Signature

Dr. S. G. Kadwane

(Head of Department Electrical Engineering)

Signature of External Examiner

Name:

Date of Examination

CERTIFICATE OF APPROVAL

Certified that the project report entitled “ **POWER FACTOR CORRECTION TECHNIQUE FOR EV BATTERY CHARGING** ” has been successfully completed by **Achal Ekunkar, Rutuja Tambekar, Shivani Kalmore, Aishwarya Khandate**, under the guidance of **Mr. Atul Lilhare** in recognition to the partial fulfilment for the award of the degree of Bachelor of Engineering in Electrical Engineering, **YESHWANTRAO CHAVAN COLLEGE OF ENGINEERING (An Autonomous Institution Affiliated to Rashtrasant Tukdoji Maharaj Nagpur University)**.

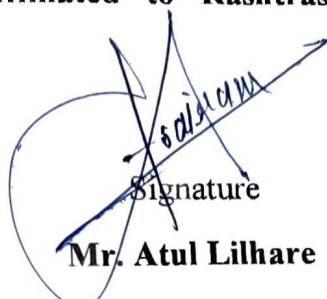
Signature
Mr. Atul Lilhare
(Project Guide)



Signature

Prof. Ujwala Waghmare
(Project Coordinator)

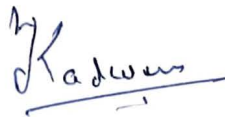

Signature

Dr. S. G. Kadwane
(Head of Department Electrical Engineering)

Signature of External

Examiner Name:

Date of Examination

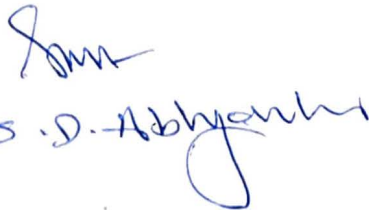

CERTIFICATE OF APPROVAL

Certified that the project report entitled “SMART MONITORING OF SUBSTATION” has been successfully completed by **Anushri A. Daryapurkar, Samiksha L. Ugale, Sanobar Anjum Sk Anis, Saurabh D. Pakde, Shubham H. Karande**, under the guidance of **Dr. Mrs. S. P. Adhau** in recognition to the partial fulfilment for the award of the degree of Bachelor of Engineering in Electrical Engineering, **YESHWANTRAO CHAVAN COLLEGE OF ENGINEERING (An Autonomous Institution Affiliated to Rashtrasant Tukdoji Maharaj Nagpur University)**.



Signature

Dr. Mrs. S. P. Adhau

(Project Guide)



Signature

Er. Jagdish Yadav (Project Manager)

MV/HV/EHV Substation (PMD-COA), Al-Riyadh (KSA)

(Project Co- Guide)



Signature

Prof. Ujwala Waghmare

(Project Co-ordinator)



Signature

Dr. Sumant Kadwane

(Head of Department Electrical Engineering)

Signature of External Examiner

Name: **P. S. Kulkarni**

Date of Examination: **02/06/22** Page 52 of 125

CERTIFICATE OF APPROVAL

Certified that the project report entitled “ **REFRIGERANT BASED AIR COOLER**” has been successfully completed by **Abhishek M. Ninawe , Kaustubh J. Dani, Mayur M. Padole, Nitin R. Jadhav, Parikshi R. Isokar ,Shantanu M. Deshpande,** under the guidance of Ms. **Swati K. Mohod** in recognition to the partial fulfilment for the award of the degree of Bachelor of Engineering in Electrical Engineering, **YESHWANTRAO CHAVAN COLLEGE OF ENGINEERING (An Autonomous Institution Affiliated to Rashtrasant Tukdoji Maharaj Nagpur University).**



Signature

Ms. Swati K. Mohod
(Guide)



Signature

Dr. Dinesh Bhoyar
(Co-Guide)



Signature

Prof. Ujwala Waghmare
(Coordinator)



Signature

Dr. Sumant Kadwane
(HOD)

Signature of External Examiner

Name:

Date of Examination:

CERTIFICATE OF APPROVAL

Certified that the project report entitled “ **Operation of Circuit Breaker with Authentication**” has been successfully completed by **Harshwardhan Mandhare, Sanket Mate, Vaishnavi Bambal, Saloni Bhoyar, Vaibhav Jiraphe, Viplav Bisen, Mrunali Dukare.**

Under the guidance of

Prof. B.S. Sudame

in recognition to the partial fulfilment for the award of the degree of Bachelor of Engineering in Electrical Engineering, **YESHWANTRAO CHAVAN COLLEGE OF ENGINEERING (An Autonomous Institution Affiliated to Rashtrasant Tukdoji Maharaj Nagpur University).**



Signature

Prof. BHARAT SUDAME

(Project Guide)



Signature

Prof. UJWALA WAGHMARE

(Project Co-ordinator)



Signature

Dr. SUMANT KADWANE

(Head of Department Electrical Engineering)

Signature of External Examiner Name:

Date of Examination:

CERTIFICATE OF APPROVAL

Certified that the project report entitled “ **OVER VOLTAGE AND UNDER VOLTAGE PROTECTION SYSTEM**” has been successfully completed by **Rakshandha Dhole, Sakshi Dharmik, Kunal Shivankar, Prajwal Belkhode, Sarang Nasare, Satvik Thote** under the guidance of **Prof. S. L. Tiwari** in recognition to the partial fulfilment for the award of the degree of Bachelor of Engineering in Electrical Engineering, **YESHWANTRAO CHAVAN COLLEGE OF ENGINEERING (An Autonomous Institution Affiliated to Rashtrasant Tukdoji Maharaj Nagpur University).**



Signature

Prof. S.L. Tiwari

(Project Guide)



Signature

Er. Jagdeesh Yadav, Project Manager

MV/HV/EHV Substation (PMD-COA), AL-Riyadh (KSA)
(Project Co- Guide)



Signature

Prof. Ujwala Waghmare

(Project Coordinator)



Signature

Dr. S. G. Kadwane

(Head of Department Electrical Engineering)

Signature of External Examiner

Name:

Date of Examination:

CERTIFICATE OF APPROVAL

Certified that the project report entitled "VIRTUAL CODING PLATFORM" has been successfully completed by **Abhishek Yadav, Akshit Panday, Prathamesh Fulkari, Sarthak Chafle** under the guidance of **Dr. Rakhi D. Wajgi** in recognition to the partial fulfilment for the award of the degree of Bachelor of Engineering in Computer Technology, Yeshwantrao Chavan College of Engineering, Nagpur (An Autonomous Institution Affiliated to Rashtrasant Tukdoji Maharaj Nagpur University)

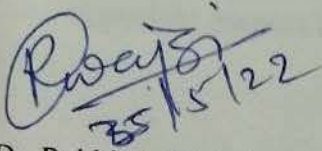

Dr. Rakhi D. Wajgi
(Project Guide)

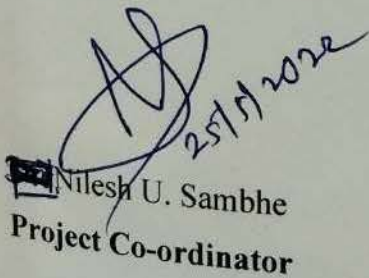

Nileshe U. Sambhe
Project Co-ordinator

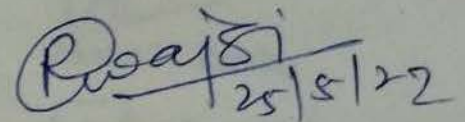

Dr. Rakhi D. Wajgi
(HOD, CT Dept.)

CERTIFICATE OF APPROVAL

Certified that the project report entitled "AUTOMATED FIRE EXTINGUISHING ROBOT" has been successfully completed by DEVYANI RAUT, INDRAYANI MUNDLE, KSHITI DANGORE AND YASH SAHARE under the guidance of **PROF. NILESH U. SAMBHE** in recognition to the partial fulfillment for the award of the degree of Computer Technology, Yeshwantrao Chavan College of Engineering, Nagpur (*An Autonomous Institution Affiliated to Rashtrasant Tukdoji Maharaj Nagpur University*)



Prof. Nilesh. U. Sambhe
Project Guide

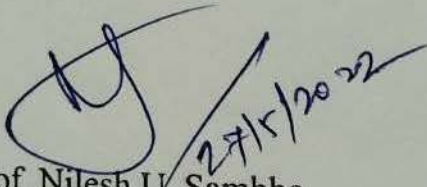

Prof. Nilesh U. Sambhe
Project Co-ordinator

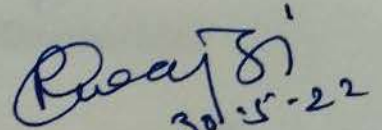

Dr. Rakhi D. Wajgi
(HOD, CT Dept.)

Yeshwantrao Chavan College of Engineering, Nagpur

FORM OF UTILIZATION CERTIFICATE

UTILIZATION CERTIFICATE FOR THE YEAR 2021-22 in respect of Non-recurring/Recurring for seed Money form the institute

1. Name of the Scheme : Innovative Minor Patentable Product
2. Title of the project: Design and Implemntation of IOT Based Smart Inverter
3. Name of Principal Investigator: Dr. Sarika Patil
4. Name of Co-Principal Investigator (If Any): Pranya Shete and Dr. S. G. Kadwande
5. Sanction Letter No.: YCCE/R and D Cell/2021-22/ Dt. 02/05/2022
6. Amount Sanctioned: Non recurring: 18,200/- Recurring: 9000/-
Total Amount Sanctioned: 27,200/-
7. Actual expenditure : Non Recurring: 11,818/- Recurring: 1,267/-
Total Expenditure (Actual): 13,086/-

Certified that the amount of Rs. 13,086/- has been utilised under Innovative Minor Patentable Product Scheme.



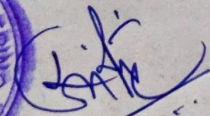

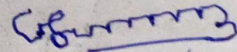
Signature of Finance Officer
Yeshwantrao Chavan College of Engineering
Wanadongri, Hingna Road
Nagpur-441110



Signature of Head of the Institute
Dr. U. P. Waghe, Principal
Yeshwantrao Chavan College of Engineering
Wanadongri, Hingna Road
Nagpur-441110

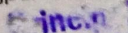

Yeshwantrao Chavan College of Engineering
Wanadongri, Hingna Road
Nagpur-441110

Report

1. Name of the Scheme : **Innovative Minor Patentable Product Scheme**
2. Title of the project: **Design and Implementation of IOT based SMART Inverter**
3. Name of Principal Investigator: **Dr. Sarika D Patil**
4. Name of Co-Principal Investigator (If Any): **NIL**
5. Sanction Letter No.: **YCCE/ R and D Cell/ 2021-2022 Dated 02.05.2022**
6. Details of Proposal

Introduction: This project work proposing for smart inverter integrating with ESP8266 wi-fi module with microcontroller which makes smart communication. Generally, users are unaware of state of charge of battery feeding power to inverter. In this work a single phase inverter is considered which is used to fed AC power to domestic load during grid power unavailability. This Proposed system monitors the various parameters of Inverter such as output voltage, load current and State of charge (SoC) of battery and provides this data to user using IoT technology. The proposed method comprises of an IoT based platform to collect and process the Inverter parameters. The data collected can be stored in the cloud platform and same can be accessed through the web page, So that user can take immediate action to avoid unwanted operation of inverter and saves charge in battery which can be utilized during essential condition. This work uses the ESP8266 Wi-Fi module including microcontroller to implement the aforesaid objectives.

This work focuses on monitoring of parameters of battery and inverter. Consumers are caught off-guard when the inverter's battery dies out as the existing inverters lack the ability to alert the users about the power consumption and battery life remaining. Present day inverters are controlled by microcontrollers and hence they are adaptive and able to send and receive messages quickly. There is scope in the existing inverters to make them more user-friendly by displaying the real time data of battery and Inverter parameter to the user by using IoT.

Working Principle: Fig. 1 shows the complete block diagram of proposed system consists of Inverter used in UPS system installed for domestic application. UPS system consists of battery and power electronics converter to convert DC to AC. To monitor various parameters such as current, voltage and SoC of battery the various sensors are required to extract data from system. This data is then processed by microcontroller and then it is fed to communication system.

Depending on the value of SoC the proposed controller decides the turn ON and OFF condition of relay.

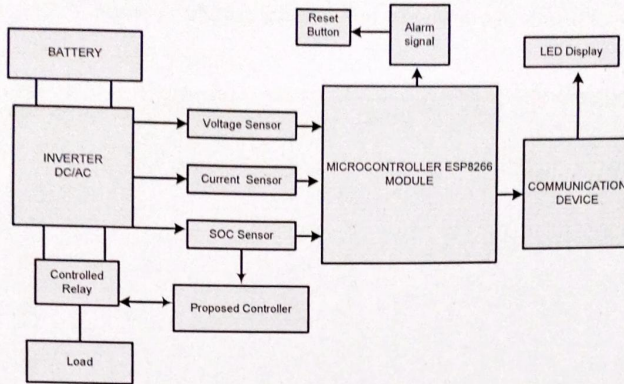

Fig.1. Block Diagram of integrated SMART INVERTER

If the SoC is greater than or equal 10% then the AC power is fed to domestic load otherwise if SoC is less than 10%, then it automatically cuts the power supply through the battery and gives signal to the user in terms of buzzer or glowing LED (Red). Fig. 2 shows the Flow chart for Process of monitoring of Current, Voltage and SoC of battery.

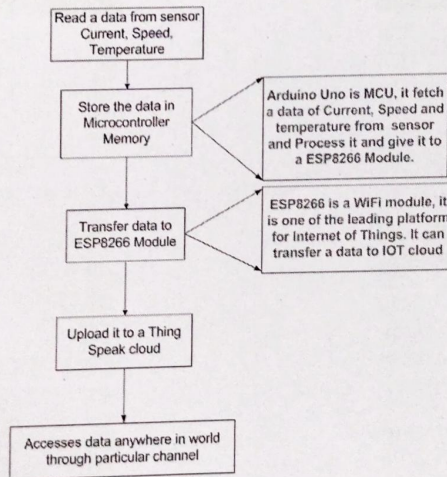

Fig. 2 Flow chart for Process of Current, Voltage and SoC

Result analysis with photographs:

The complete hardware setup for IOT based smart inverter along with load is shown in fig.3 below. It includes 12 V battery, 950VA transformer, inverter kit, current sensor and voltage sensor along with ESP8266 Wi-fi module.

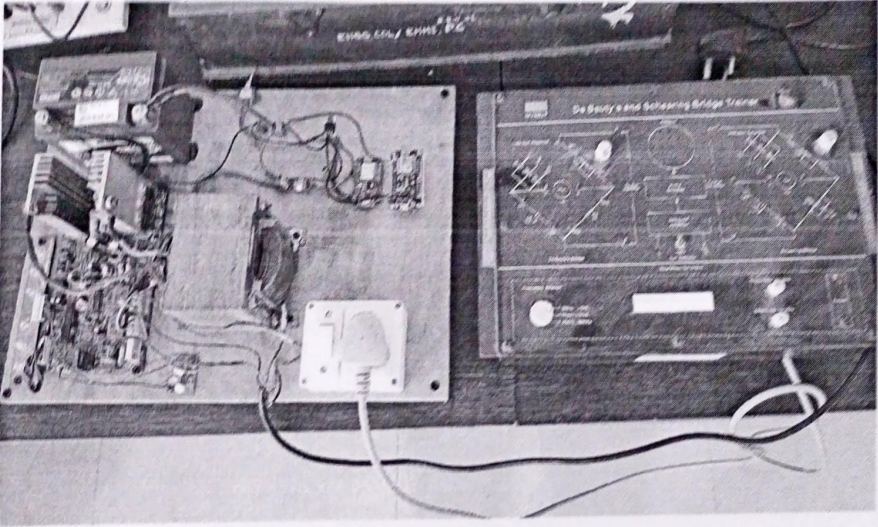

Fig. 3 Complete hardware setup along with load

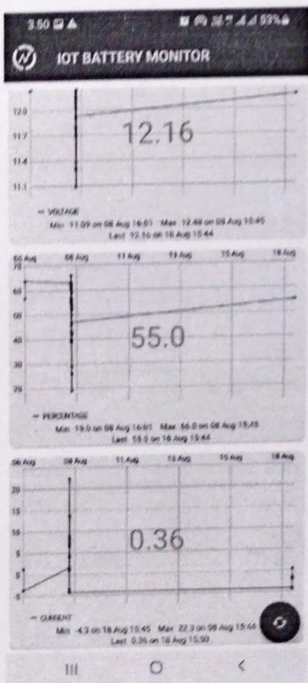

Fig. 4 Parameters without Load

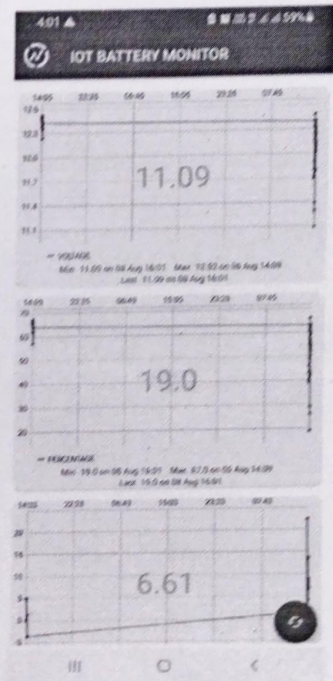
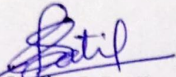

Fig. 5 Parameters with Load

Conclusion:

The complete hardware setup is tested under No-Load and Load condition and it is working successfully. Under No-Load condition the parameters of battery i.e. voltage, current and SoC are monitored and recorded. It is observed that under No-Load condition, current is 0.36A, Voltage is 12.16V and SoC is 55% . Also under Load condition, current is 6.61, Voltage is 11.09V and SoC is 19%. When the SoC of battery is less than 10%, relay will automatically cut the supply from battery and gives alarming indication to the user. Here RED LED will glow and buzzer will be activated.

7. Applications where the product/Setup used for: This product will be utilized for hotels, flat schemes, Banks, Hospitals, industries as well as for domestic purpose.



Dr. Sarika D Patil

Principal Investigator

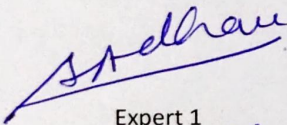

Expert 1

Dr. S. P. Adhau
Asso. Prof.

Head of EL

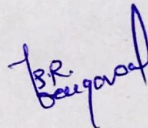

Expert 2

S. R. Gaigawal
Assistant Prof.
EL Dept.

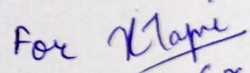

Dr. S. G. Kadwane
HOD-EL

Head of Department
Electrical Engg.
V.C.C.E., Nagpur

(Uma Pate)



Date: 17/05/2022

To,
The Principal,
Y.C.C.E, Nagpur

Sub: Regarding release of sanction amount for Inhouse minor patentable product scheme

Respected Sir,

This is to bring into your kind notice that my proposal titled, "Design and Implementation of IOT based smart inverter" is recommended and approved for financial assistance of Rs. 27,200/- Kindly sanction the amount of Rs. 15,000/- as a advance for the same .

Enclosure:

1. Sanction Letter

Your's faithfully

Dr. Sarika D Patil
Assistant Professor,
EL Department
YCCE, Nagpur

Forwarded

(Dr. S.C. Kadam)

H.O.D, EL

OK

17.05
ACHT Bhatt

YESHWANTRAO CHAVAN COLLEGE OF ENGINEERING
HINGNA ROAD, WANADONGRI
NAGPUR

ADVANCE SLIP

Slip NO. _____

Date : 17/5/2022

Name of person : Dr. Sarika. D. Patil

On the Account of	Amount	Likely date of settlement
Advance for Inhouse minor patentable Product scheme	15000/-	Upto 31st August 2022
Total		

NOTE :

1. Bill should be presented to accounts department, duly approved, by the due date above but in any case not later than one month from the date of advance.
2. If bills/details are not submitted in above period, amount will be deducted from salary in case of staff and in case of outsider penalty equivalent to 2% per month or part thereof (sub to minimum of Rs.100/-) will be recovered.
3. In case of extension required in settlement due to any genuine reason the same need to be approved in writing by the sanctioning authority.
4. Remark, if any _____

Sanction Rs. _____

Kadum
(Dr. S. G. Kadum)
HOD/Section-Incharge

G. S. Patil
17-05
Principal/Authorized Signatory

Patil
Receiver Signature

Sold By :
ATM Retail
Building 2 (Wh 2), Plot no. 12/P2 (IT Sector),
HITECH, Defence and Aerospace Park, Devanahalli
Bengaluru, Karnataka, 562149
IN

Billing Address :
Principal, Yashwantrao Chavan
College of Engineering,
NAGPUR, MAHARASHTRA,
441110.
IN
State/UT Code:27

PAN No: ABBFA8629H
GST Registration No: 29ABBFA8629H1Z8
Dynamic QR Code:

Shipping Address :
Principal, Yashwantrao Chavan
College of Engineering,
NAGPUR, MAHARASHTRA,
441110.
IN



State/UT Code:27
Place of supply: MAHARASHTRA
Place of delivery: MAHARASHTRA
Invoice Number : BLR8-11076

Order Number: 407-1089939-3465290
Order Date: 08.06.2022

Invoice Details : KA-BLR8-1417301695-2288
Invoice Date : 08.06.2022

Sl.	Description	Unit Price	Discount	Qty	Net Amount	Tax Rate	Tax Type	Tax Amount	Total Amount
1.	Battery Tz5 Exide	₹1750.00	00	1	₹1750.00	18%	IGST	₹315.00	₹2065.00
2.	Node mcu Esp8266 Ai Thinker	₹649.00	00	2	₹1298.00	18%	IGST	₹233.64	₹1531.64
								₹548.64	₹3596.00

Three Thousand Five Hundred And Ninety Six Rs only

For ATM Retail:

Jathuram

Authorized Signatory

Whether tax is payable under reverse charge - No

Y.C.C.E
Gate Entry Stamp
Date: 28/06/22 Entry No: 579
Security duty Supervisor
Susendra G
Signature
Nagpur

voice

Order ID: OD223080536436454000
Order Date: 25-05-2022, 04:31 PM

Invoice No: FAESD92200008087
Invoice Date: 25-05-2022, 08:15 AM

GSTIN: 07C:GPK3425E1ZH
PAN: CJGPK3425E



By
Stokin,
House No 77 G/F Bharat Nagar New Friends Colony
Near bank of baroda,
NEW DELHI - 110025

Shipping ADDRESS
Principal,
Yashwantrao College
Of Engineering,
Nagpur-441110,IN-MH

Billing Address
Principal,
Yashwantrao College
Of Engineering,
Nagpur-441110,IN-MH

Product	Description	Qty	Gross Amount	Discount	Taxable Value	IGST	Total
NKTRONICS,PURE SINE WAVE INVERTER TRANSFORMER 950VA	HSN: 85158090 IGST: 18%	1	3099.00	-0.00	3099.00	575.82	3656.00
TOTAL QTY: 1	Shipping Charge	1	0.00	0	0.00	0.00	0.00

TOTAL PRICE: 3656.00
All values are in INR

Seller Registered Address: Stokin,
Stokin, Gali no 3, BHARAT NAGAR - 110025.

Declaration
The goods sold are intended for end user consumption and not for resale.

E. & O.E.

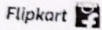

Ordered Through

Stokin
Authorized Signature

Y.C.C.E
Gate Entry Stamp
 Date 28/07/22 Entry No 380
 Security duty Supervisor
[Signature]
 Signature
 Nagpur

Sold By :
 ATM Retail
 Building 2 (Wh 2), Plot no. 12/P2 (IT Sector),
 Hitech, Defence and Aerospace Park, Devanahalli,
 Bengaluru, Karnataka, 562149
 IN

Billing Address :
 Principal, Yashwantrao Chavan
 College of Engineering,
 NAGPUR, MAHARASHTRA,
 441110.
 IN
State/UT Code:27

PAN No:ABBFA8629H
GST Registration No:29ABBFA8629H1Z8
Dynamic QR Code:



Shipping Address :
 Principal, Yashwantrao Chavan
 College of Engineering,
 NAGPUR, MAHARASHTRA,
 441110.
 IN
State/UT Code:27

Order Number:407-1089939-3465169
Order Date:28.05.2022

Place of supply:MAHARASHTRA
Place of delivery:MAHARASHTRA

Invoice Number :BLR8-1108
Invoice Details :KA-BLR8-1413601695-2223
Invoice Date :28.05.2022

Sl.	Description	Unit Price	Discount	Qty	Net Amount	Tax Rate	Tax Type	Tax Amount	Total Amount
1.	Inverter kit 850VA Microtek	₹3870.00	00	1	₹3870.00	18%	IGST	₹696.60	₹4566.60
2.	Heat sink 80n.	₹52.00	00	2	₹104.00	18%	IGST	₹18.72	₹122.72
3.	Voltage sensor module 25v	₹320.00	00	1	₹320.00	18%	IGST	₹57.60	₹377.60
4.	Current sensor ACS	₹650.00	00	1	₹650.00	18%	IGST	₹117.00	₹767.00
								₹889.92	₹5833.00

Five Thousand Eight Hundred And Thirty Three Rs only

For ATM Retail:

Jathumar
 Authorized Signatory

Whether tax is payable under reverse charge - No

V.C.C.E
Gate Entry Stamp
 Date: 28/05/22 Entry No: 381
 Security duty Supervisor
Signature
 NAGPUR

*ASSPL-Amazon Seller Services Pvt. Ltd., ARIPL-Amazon Retail India Pvt. Ltd. (only where Amazon Retail India Pvt. Ltd. fulfillment center is co-located)

Customers desirous of availing Input GST credit are requested to create a Business account and purchase on Amazon.in/business from Business eligible offers

Please note that this invoice is not a demand for payment



Nagar Yuwak Shikshan Sanstha's

Yeshwantrao Chavan College of Engineering

(An Autonomous Institution affiliated to Rashtrasant Tukadoji Maharaj Nagpur University)

Hingna Road, Wanadongri, Nagpur - 441 110

07104-237919, 234623, 329249, 329250 Fax: 07104-232376, Website: www.ycce.edu

Electrical Engineering Department

Date: 19/08/2022

To,
The Accounts Department
YCCE, Nagpur

Sir/Madam,

This is to inform you that, my project titled, "Design and Implementation of IOT based SMART Inverter" has been approved under Innovative Minor Patentable Product Scheme. Total amount of Rs. 27,200/- has been sanctioned for the same. The advance of Rs. 15,000/- has been taken from accounts department for completing this project. The actual expenditure for this project is as under.

S.N.	Particulars	Recurring/Non Recurring	Total Amount (Incl Tax.) (Rs.)
1.	Node MCU ESP8266 Ai Thinker	Non Recurring	1531.64
2.	Battery Tz5 Exide		2065.00
3.	Inverter Transformer 950VA		3656.00
4.	Inverter kit 850VA (Microtek)		4566.60
5.	Heat Sink 80n (2 No.)	Recurring	122.72
7.	Voltage sensor module (25V)		377.60
8.	Current Sensor ACS		767.00
TOTAL (Rs.)			13086.56

Particulars	Amount (Rs.)	
Advance Taken	15000.00	
Actual Expenses done	13086.56	
Remaining amount	1913.44	Paid by cash to accounts department Receipt no. 46/c12/c/22/ on dated 20/8/2022 3086

Dr. Sarika.D. Patil
Assistant Professor

Electrical Engg Department

Enclosures:-

- Bills of the Materials
- Copy of Sanction Letter
- Project completion report
- Receipt of Rs. 1914/-

For NA

Page 68 of 125

AL



Nagar Yuwak Shikshan Sanstha's
Yeshwantrao Chavan College of Engineering

(An Autonomous Institution affiliated to Rashtrasant Tukadoji Maharaj Nagpur University)

Hingna Road, Wanadongri, Nagpur - 441 110

Ph.: 07104 - 242919, 242623, 242588, Website : www.ycce.edu, Email : principal@ycce.edu

RECEIPT

Receipt No. : YC/C12/C/22/3096 Date : 20/08/2022
Rec.From : Advance settlement by Dr Sarika Patil (Dept - Electrical Engg)
Receipt Type : OTHER RECEIPTS

PARTICULARS	AMOUNT
ADVANCE	1,914

Total Amount : 1,914

In words : One Thousand Nine Hundred Fourteen Only.

Cash Amount : 1,914 D.D. Amount : 0

DD No.	Date	Issuing Bank	Amount

Remark: Innovative Minor Patent product scheme

Signature of Cashier:

20/08/2022 12:10:34 pm

NEERAJ SATYADEV DWIVEDI

Statement of Account

No : 82561
 No : 007002300006181
 Address : **SARIKA DINESH PATIL**
 : 2 JAIBHIM NAGAR RAMESHWARY RD
 OPP AMBEDKAR STATUE
 NAGPUR
 Nagpur-440027

Branch Name : YCCE Branch
 Branch IFSC : HDFCOCTUB07
 Generated On: 26-09-2022 02:59

From Date : 01-MAY-2022 To 31-AUG-2022

Opening Balance : 32,491.17

Entry Date	Ins No	Perticulars	Debit	Credit	Balance
01-05-2022	212190	UPI/057499/Dt:01-05-2022/607147/UPI.NPCI XXXXXXXXX/		3.00	32,494.17
01-05-2022	212082	UPI/430932/Dt:30-04-2022/607147/UPI.NPCI XXXXXXXXX/	2,449.00		30,045.17
01-05-2022	212082	UPI/523313/Dt:30-04-2022/607147/UPI.NPCI XXXXXXXXX/	4,250.00		25,795.17
04-05-2022	212480	UPI/985154/Dt:04-05-2022/607147/UPI.NPCI XXXXXXXXX/	520.00		25,275.17
04-05-2022	212481	UPI/421728/Dt:04-05-2022/607147/UPI.NPCI XXXXXXXXX/	210.00		25,065.17
04-05-2022	212482	UPI/540078/Dt:04-05-2022/607147/UPI.NPCI XXXXXXXXX/	1.00		25,064.17
04-05-2022	212482	UPI/576253/Dt:04-05-2022/607147/UPI.NPCI XXXXXXXXX/	15,000.00		10,064.17
05-05-2022	212519	UPI/138433/Dt:05-05-2022/607147/UPI.NPCI XXXXXXXXX/	500.00		9,564.17
09-05-2022		OrigBrCd = 2 NEFT PUNBH22127165101 YESHW NTRAO CHAVHAN COLLEGE OF EN 1		74,199.00	83,763.17
09-05-2022	212976	UPI/523364/Dt:09-05-2022/607147/UPI.NPCI XXXXXXXXX/	299.00		83,464.17
10-05-2022	213006	ATM-CHARGES/CHARGES	5.00		83,459.17
10-05-2022	213006	GST ON ATM-CHARGES/CHARGES	0.45		83,458.72
10-05-2022	213006	IMPS/213006683067/SARIKA D PATIL/3230054 425/SBIN0000432/Self account/	10,000.00		73,458.72
10-05-2022	213006	CGST ON ATM-CHARGES/CHARGES	0.45		73,458.27
11-05-2022	213037	UPI/177417/Dt:10-05-2022/607147/UPI.NPCI XXXXXXXXX/	300.00		73,158.27
11-05-2022	213151	UPI/849233/Dt:11-05-2022/607147/UPI.NPCI XXXXXXXXX/	1,180.00		71,978.27
16-05-2022	213555	UPI/385342/Dt:15-05-2022/607147/UPI.NPCI XXXXXXXXX/	200.00		71,778.27
16-05-2022	213555	UPI/420304/Dt:15-05-2022/607147/UPI.NPCI XXXXXXXXX/	340.00		71,438.27
20-05-2022	214061	UPI/108767/Dt:20-05-2022/607147/UPI.NPCI XXXXXXXXX/	2,500.00		68,938.27
21-05-2022	214177	UPI/117229/Dt:21-05-2022/607147/UPI.NPCI XXXXXXXXX/	470.82		68,467.45
21-05-2022	214179	UPI/094449/Dt:21-05-2022/607147/UPI.NPCI XXXXXXXXX/	399.00		68,068.45
21-05-2022		REMUNERATION YCCE/		240.00	68,308.45
21-05-2022		REMUNERATION/		80.00	68,388.45
23-05-2022	214217	UPI/560371/Dt:22-05-2022/607147/UPI.NPCI XXXXXXXXX/	702.00		67,686.45
24-05-2022	214333	UPI/555971/Dt:23-05-2022/607147/UPI.NPCI XXXXXXXXX/	350.00		67,336.45
26-05-2022		OrigBrCd = 2 ABB TR FROM CA-130 YESHWANT AO CHAVAN COLLEGE OF ENGG.		15,000.00	82,336.45
26-05-2022	214648	UPI/459797/Dt:26-05-2022/607147/UPI.NPCI XXXXXXXXX/	10,000.00		72,336.45
26-05-2022	214688	UPI/782744/Dt:26-05-2022/607147/UPI.NPCI XXXXXXXXX/	60.00		72,276.45
27-05-2022	214710	UPI/740480/Dt:27-05-2022/607147/UPI.NPCI XXXXXXXXX/	500.00		71,776.45
27-05-2022	214763	UPI/649937/Dt:27-05-2022/607147/UPI.NPCI XXXXXXXXX/	185.00		71,591.45
28-05-2022	214828	UPI/595621/Dt:28-05-2022/607147/UPI.NPCI XXXXXXXXX/	1,500.00		70,091.45

Yeshwantrao Chavan College of Engineering, Nagpur

FORM OF UTILIZATION CERTIFICATE

UTILIZATION CERTIFICATE FOR THE YEAR 2022-23 in respect of recurring/non recurring for seed Money from the institute.

1. Name of the Scheme: Innovative Experimental Setup
1. Title of the project: Center of gravity Experiment for regular and irregular shapes.
2. Name of Principal Investigator: Mrs.V.N.Mendhe
3. Name of Co-Principal Investigator (If Any): NA
4. Sanction Letter No.: YCCE/R and D Cell/2021-22/568 Dt. 16/04/2022
5. Amount Sanctioned: Recurring: Nil, Non-recurring: 5000/-
Total Amount Sanctioned: 5000/-
6. Actual expenditure: Recurring: Nil/- Non recurring: 3638/-
Total Expenditure (Actual): 3638/-

Certified that the amount of Rs. 3638/- has been utilised under Innovative Minor Patentable Product/Innovative Experimental Set up scheme.

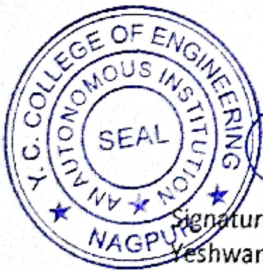

Signature of Finance Officer
Yeshwantrao Chavan College of Engineering
Wanadongri, Hingna Road
Nagpur-441110

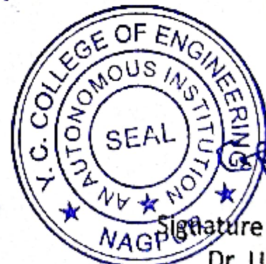

Signature of Head of the Institute
Dr. U. P. Waghe, Principal
Yeshwantrao Chavan College of Engineering
Wanadongri, Hingna Road
Nagpur-441110

Yeshwantrao Chavan College of Engineering, Nagpur

FORM OF UTILIZATION CERTIFICATE

UTILIZATION CERTIFICATE FOR THE YEAR 2021-22 in respect of Non-recurring/Recurring for seed Money form the institute

1. Name of the Scheme : Innovative Minor Patentable Product
2. Title of the project: Development of Power Factor Correction Device for Residential Load
3. Name of Principal Investigator: Atul Lihhare
4. Name of Co-Principal Investigator (If Any): Pranya Shete and Dr. S. G. Kadwande
5. Sanction Letter No.: YCCE/R and D Cell/2021-22/ Dt. 16/09/2021
6. Amount Sanctioned: Non recurring: 6,100/- Recurring: 5000/-
Total Amount Sanctioned: 11,100/-
7. Actual expenditure : Non Recurring: 5,592/- Recurring: NIL
Total Expenditure (Actual): 5,592/-

Certified that the amount of Rs. 5,592/- has been utilised under Innovative Minor Patentable Product Scheme.

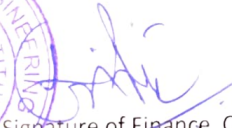

Signature of Finance Officer
Yeshwantrao Chavan College of Engineering
Wanadongri, Hingna Road
Nagpur-441110



Signature of Head of the Institute
Dr. U. P. Waghe, Principal
Yeshwantrao Chavan College of Engineering
Wanadongri, Hingna Road
Nagpur-441110

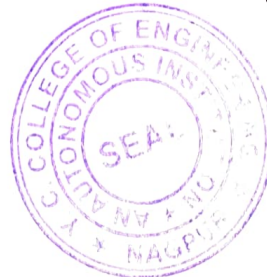

Principal
Yeshwantrao Chavan
College of Engineering
Wanadongri Hingna Road
NAGPUR-441110

Report

1. Name of the Scheme : Innovative minor patentable product
2. Title of the project: **Development of Power Factor Correction device for residential load.**
3. Name of Principal Investigator: Mr.A.S.Lilhare
4. Name of Co-Principal Investigator (If Any): Mr.P.S.Shete, Dr.S.G.Kadwane
5. Sanction Letter No.: YCCE/R&D CELL/2021-22/
6. Details of Proposal

I. Introduction

Today, we are observing an ever-increasing demand for electrical energy if we can contribute a smaller device to improve power factor and reduce the loss in any sector then it can give a little boost to the idea of saving and using the energy that we have more effectively and efficiently. Generally, the use of inductive load in the system increases the reactive load in the system. So that current lag behind the voltage, it occurs lagging power factor due to this the efficiency of the system get reduces and electricity bill gets increase [1]. Also, due to significant phase difference between voltage and current at the load terminal, system draw a power at low power factor, it means it also have a distorted waveform.

So many methods are developed now a days in order to monitor and control the power factor of residential load. In [2], one of the most important converter is used for water pumping application which is further utilized for the development power factor correction in water pumping application of residential load as mentioned in [3].

A well system is developed to achieve high power factor in single phase system by operating in continuous conduction mode which work on the principal of avaregae current mode control. In [5], a microcontroller device is used which ensure automatic correction of the power factor without operator. The triac based power factor corrector for singlr phase domestic load is proposed in [6]. Other approach [7] is to use a PFC device for each load means in multiple way in order to acieve a desired power qualityin the area of residential load. Instaed of above a concept of filter and capacitor compensator (MPF/C) Green Plug is used for effective energy conservation, for 2 phase, 3 wire household load [8]. An open source energy monitoring library were implemented in order to monitor the energy consumption of a system and automatically improve its power factor [9].

With above discussion , it observed that there is still some scope to work in the area of residential load for power factor improvement. There is need of development of cheper and effective power factor correction device which will be able to maintain unity power factor at residential load. This paper deals with automatic monitoring and improvement of power factor with the help of embedded system. It simple consist of Arduino board , capacitor bank and relays. Instead of CT and PT , voltage and current sensors are used. This sensors are

$$Z = R + jX_L \quad \dots(1)$$

$$Z = 10 + j(2\pi \times 50 \times 0.31831) = 100.49 \angle 84.28^\circ \Omega$$

The current drawn by the load is

$$I = \frac{V}{Z} \quad \dots(2)$$

$$I = \frac{220 \angle 0^\circ}{100.49 \angle 84.28^\circ \Omega} = 2.19 \angle -84.28^\circ A$$

Nature of the current is lagging as the phase angle is negative. Similarly, the complex power of the load is calculated as

$$S = VI^* \quad \dots(3)$$

$$S = 220 \angle 0^\circ \times 2.19 \angle -84.28^\circ = 481.8 \angle -84.28^\circ VA$$

$$S = 48.02 - j479.401 VA$$

Once complex power is evaluated, power factor can be calculated as shown in equation in(4).

$$p.f = \frac{P}{S} = \frac{48.02}{481.8} = 0.0996 \quad \dots(4)$$

B. Capacitive bank for Unity power factor operation

For unity power factor operation, the complex power should be equal to active power which means that total reactive power drawn by the system is zero. By submitting the imaginary part of load current is zero, the power factor of the system can be improved. So reactive power required to fed by capacitor is

$$Q_C = 479.401 Var$$

With the help of equation (5), capacitive reactance can be calculated, once the value of reactance known, required value of capacitor is determined from equation (6).

$$Q_C = \frac{V^2}{X_C} \quad \dots(5)$$

$$X_C = \frac{V^2}{Q_C} = \frac{220^2}{479.401} = 100.96 \Omega$$

$$X_C = \frac{1}{2\pi f C} \quad \dots(6)$$

$$C = \frac{1}{2\pi f X_C} = \frac{1}{2\pi \times 50 \times 100.96} = 31.52 \mu F$$

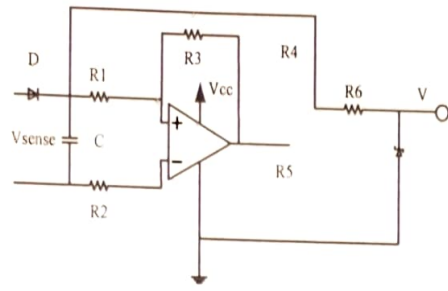

Fig.4 Current sensing circuit for PFC Unit for residential load

Similarly, bias resistor sensed the current and convert it into voltage as controller only work on voltage signal. This generated voltage is passed through zero crossing detector so that zero crossing from positive half cycle to negative half cycle can be detected. This generated signal is then fed to controller as sense current signal as shown in figure 4.

C. Controller circuit

A microcontroller is the heart of the system. It will sense the phasor term of voltage and current from sensing unit. After receiving information it will manipulate phase angle and phase difference between this two waves. This information information display on LCD screen. A microncontroller detect the angle between current and voltage signal and Once angle information is confirmed , a value of power factor is obtained. Depend upon the power factor value , controller will take a decision of switch in or out of capacitor in such way that the system power factor will remain at unity value.

D. Relay Driver Circuit

Relay driver as shown in figure 5, ensure connection or disconnection of capacitor in the circuit. Relay work is totally depend on the signal send by the controller. It means relay on its own can not controlled the switching of capacitor in the system.

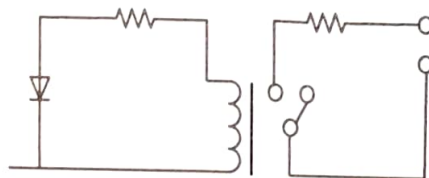

Fig.5 Relay driver circuit for PFC Unit for residential load

V. Simulation result of the proposed system

The said system is tested with the help MATLAB software. By considering the all parameter as mentioned in above parameter design , the results are obtained.

Figure 6 shows a result for supply voltage and current. At initial stage, due to inductive load , system draw a current which is lag to the supply voltage as shown in figure 7. This phase angle is sensed by the PFC unit , so it switch on the capacitor in circuit at 0.5 sec in order to achieve the unity power factor as shown in figure 6. It can be observe that , magnitude of current is decreased and its in phase with the supply voltage as shown in figure 8.

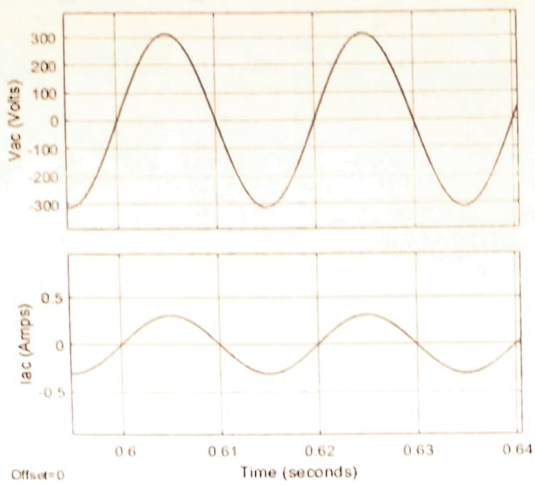

Fig.8 Supply voltage and In phase current of PFC Unit for residential load

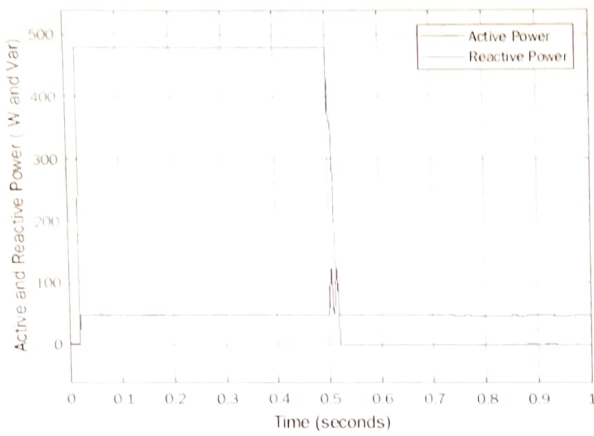

Fig.9 Active and Reactive power of PFC Unit for residential load

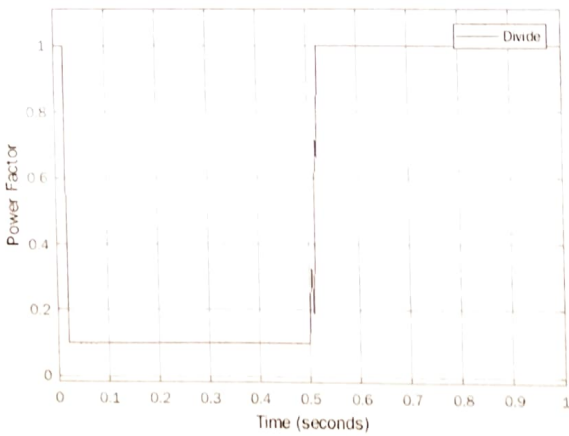

Fig.10 Power factor of PFC Unit for residential load

7. Applications where the product/Setup used for:

Our power factor correction device will take a care of unity power factor at residential load so that rated amount of supply voltage and supply current will maintain. This device also help to improve the efficiency of the overall system, at same time it also help to reduce the electricity bill. After switching ON or OFF of capacitor bank in the system, the surge in voltage appears so this surge in voltage should not be cross its range in such a way that the system will remain unaffected. so therefore surge protection is also provided in this devices.



Mr.P.S.Shete
Co-Principal Investigator



Dr.S.G.Kadwane
Co-Principal Investigator

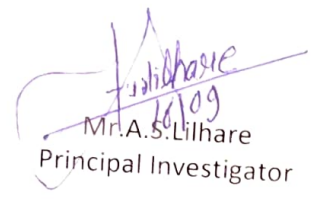

Mr.A.S.Lilhare
Principal Investigator

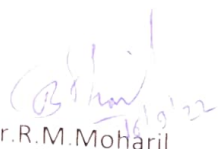

Dr.R.M.Moharil
Expert Member 01

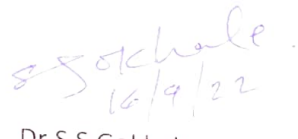

Dr.S.S.Gokhale
Expert Member 02

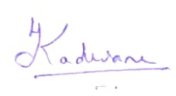

Dr.S.G.Kadwane
HoD,EL

Head of Department
Electrical Engg.
Y.C.C.E., Nagpur

SIDDHI

Siddhi Infotech Enterprises

Plot No.11/2, Bharat Mata Nagar
Area of Swagat Nagar, New Narsala
Nagpur-400 034
Mob No: 9028028301, 9765020820
E- mail:-info.siddhi10@gmail.com

TAX INVOICE 2021-22

To, The Principal Yeshwantrao Chavan College of Engineering Hingna Road, Wanadongri Nagpur - 441 110	Invoice No.: SIE/INV/21-22/47 Date:03/01/2022 D. M. No.: SIE/DC/21-22/47 Date: 03/01/2022 Buyer's PO NO: 808-YCCE/POHO/21-22/193 Dated: 21/12/2021 Date of handling PO:24/12/2021 GSTN NO.: 27DNUPS5374D1ZA
--	--

Contact Person: - HOD of the ETRX Dept.

S N	Description of Good	Units	HSN Code	Qty	Rate	Amount
1	ZMPT 101B AC single phase voltage sensor 250V	1 sets	8542	02	325	650
2	Current sensor module ACS712-20A		9031	02	200	400
3	Arduino Uno R-3		8473	01	590	590
4	IC7805 Voltage Regulator			06	10	60
5	Relay Module 5 Channel 5V SSR			01	1000	1000
6	ULN2003		8517	01	20	40
7	Capacitor Ceramic 101		8542	02	1	12
8	Capacitor Ceramic 102		8302	12	1	12
9	Capacitor Ceramic 103			12	1	12
10	Capacitor Ceramic 104			12	1	12
11	Capacitor 2.5MFD			14	1	14
12	Capacitor 4MFD			02	90	180
13	Capacitor 10MFD		8302	02	120	240
14	Center Tap transformer 18-0-18, 500mA			04	200	800
15	16*2 LCD display 18V			01	100	100
16	Multi stand wire 10mtr		8531	01	150	150
17	Teflon Tape			01	50	50
18	Diode 1N4007			01	250	250
				10	1	10

Bank Details: BANK :-PUNJAB NATIONAL BANK BRANCH : NANDANWAN, NAGPUR-400 009 A/c no:- 4608002100002636 RTGS/NEFT IFS CODE NO:- PUNB0460800	Total Amount	4570
	Taxable Value	4570
	Add CGST@9%	411.3
Certified that the particulars given above are true & correct Terms & Conditions of Sale 1. Goods once sold will not be accepted back 2. Interest @24% p. a. will be charged if payment not made in 15 days Subject to Nagpur Jurisdiction	Add SGST@9%	411.3
Amount (In Words): Five Thousand Five Hundred Ninety Two Only	Add IGST@18%	--
	Tax Amount GST	822.6
	Transportation Charges	200
	Total Value(Amt) (Round-up)	5,592



For SIDDHI INFOTECH ENTERPRISES

SIDDHI

Siddhi Infotech Enterprises

Plot No. 11/2, Bharat Mata Nagar
Area of Swagat Nagar, New Narsala
Nagpur-400 034

Mob. No: 9028028301, 9765020820
E- mail:-info.siddhi10@gmail.com

DELIVERY CHALLAN

Ref. No.: SIE/DC/21-22/47

Date: 03/01/2022

To,
The Principal
Yeshwantrao Chavan College of Engineering
Hingna Road, Wanadongri
Nagpur - 441 110

Contact Person: - HOD of the ΣE ETRX Dept.

Buyer's PO NO: 808-YCCE/POHO/21-22/193 Dt. 21/12/2021 Date of handling PO: 24/12/2021

S. N.	Particulars	Qty	Remark
1	ZMPT 101B AC single phase voltage sensor 250V	02	
2	Current sensor module ACS712-20A	02	
3	Arduino Uno R-3	01	
4	IC7805 Voltage Regulator	06	
5	Relay Module 8 Channel 5V SSR	01	
6	ULN2003	02	
7	Capacitor Ceramic 101	12	
8	Capacitor Ceramic 102	12	
9	Capacitor Ceramic 103	12	
10	Capacitor Ceramic 104	14	
11	Capacitor 2.5MFD	02	
12	Capacitor 4MFD	02	
13	Capacitor 10MFD	04	
14	Center Tap transformer 18-0-18, 500mA	01	
15	16*2 LCD display 18V	01	
16	Multi stand wire 10mtr	01	
17	Teflon Tape	01	
18	Diode IN4007	10	

RAN
03/01/22



FOR SIDDHI INFOTECH ENTERPRISES

[Handwritten Signature]

Report

1. Name of the Scheme: In-house Scheme of Innovative Experimental Research
2. Title of the project: Center of gravity Experiment for regular and irregular shapes.
3. Name of Principal Investigator: Mrs.V.N.Mendhe
4. Name of Co-Principal Investigator (If Any): NA
5. Sanction Letter No.: YCCE/R and D Cell/2021-22/568
6. Details of Proposal: -

Introduction- The center of gravity (CG) of a body is the point at which its weight is concentrated. This point may be within or outside the body. This is the point where it balances itself when on knife-edge support. Locating the center of gravity of an object is very important in our daily lives. The earth pulls down on each particle of an object with a gravitational force that we call weight. The net effect is as if the total weight of the object were concentrated in a single point. In general, determining the center of gravity (CG) is a complicated procedure because the (mass and weight) may not be uniformly distributed throughout the object. The general case requires the use of calculus.

Working Principal- If the mass is uniformly distributed; the problem is greatly simplified. If the object has a line or plane of symmetry, the CG lies on the line of symmetry. For a solid block of uniform material, the center of gravity is simply at the average location of the physical dimensions. Regularly shaped bodies have CG at their geometric centers. In irregular elongated bodies CG can be located by balancing method. While, irregular flat bodies like a sheet model or board center of CG is located by locating two or more plumb lines from different points of suspension. The intersection of these plumb lines is the center of gravity.

Results analysis with photographs- Experimental set up was fabricated. It was then installed at Engineering Mechanics Lab. YCCE, Nagpur.

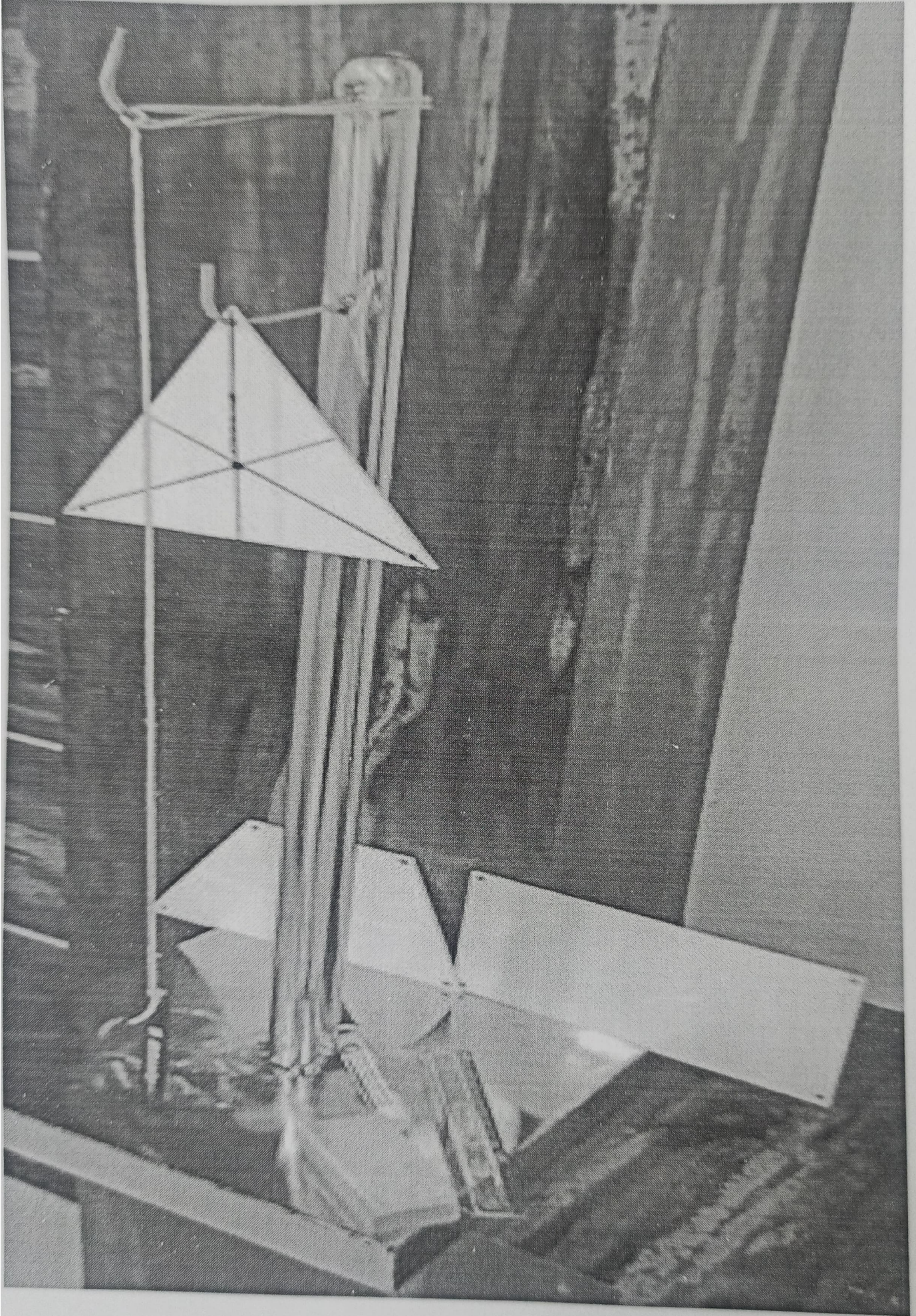

Figure 1: New Innovative Experimental Setup

Table 1: Result analysis

Shape	Formula	Theoretical Value	Practical Value
Rectangle (b=20 cm, h= 12 cm)	$\bar{X} = \frac{b}{2}$ $\bar{Y} = \frac{h}{2}$	$\bar{X} = 10 \text{ cm}$ $\bar{Y} = 6 \text{ cm}$	$\bar{X} = 9.9 \text{ cm}$ $\bar{Y} = 5.9 \text{ cm}$
Isosceles Triangle (b = 17 cm, h = 14.72 cm)	$\bar{X} = \frac{b}{2}$ $\bar{Y} = \frac{h}{3}$	$\bar{X} = 8.5 \text{ cm}$ $\bar{Y} = 4.90 \text{ cm}$	$\bar{X} = 8.4 \text{ cm}$ $\bar{Y} = 5 \text{ cm}$
Trapezium (base at bottom, b= 20 cm, base at top, a=10 cm, h = 12 cm)	$G = [b + 2a/3 (a + b)] * h$	$\bar{Y} = 5.33 \text{ cm}$	$\bar{Y} = 5.35 \text{ cm}$

Conclusion- The results show that theoretical and experimental value of three shapes is matched with the limit of error.

7. Applications where the product/Setup used for:

This product/setup is useful for the Engineering Mechanics course for first-year students for locating the center of gravity of regular and irregular shapes



Dr. V.G. Meshram

Expert & Professor,
CED, YCCE, Nagpur

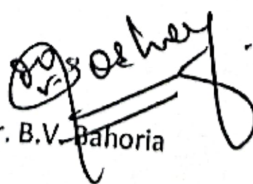

Dr. B.V. Dahooia

Expert & Professor,
CED, YCCE, Nagpur

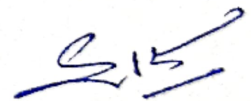

Dr. S. P. Raut

HOD, Civil Engg.,
YCCE, Nagpur

Yeshwantrao Chavan College of Engineering
(An Autonomous Institution affiliated to Rashtrasant Tukadoji Maharaj Nagpur University)

Hingna Road, Wanadongri, Nagpur - 441 110
Ph.: 07104-237919, 234623, 329249, 329250 Fax: 07104-232376, Website: www.ycce.edu

NOTE

Subject: - Settlement of Purchasing for New Experimental Setup under In-house Scheme of Innovative Experimental Research. Date: 01/10/2022

With reference to the above subject, the accessories are purchased to develop the new experimental setup (Center of Gravity Experiment) after approval of financial assistance of 5000/- from committee for the proposal under In-house Scheme of Innovative Experimental Research.

Sr. No.	Name of Item/Goods	Quantity	Amount in Rs.
1	Steel Stand	01.	2500.00
2	Acrylic Sheet (Rectangular, Triangle, Trapezium) Invoice No. 131 Dated: 24 th Sep. 2022	03	1062.00
3	Whiteboard Marker Pen (02) & Duster (02)	04	76.00
Total			3638.00

Expenditure Incurred: Rs. 3638.00/-

Proposal Approved by Committee: Rs. 5000/-

It is therefore requested to sanction the expenditure **3638.00** (Rs. Three Thousand Six Hundred & thirty-eight Only).

Mrs. V.N. Mendhe
Department of Civil Engg.

Submitted to,
Principal, YCCE, Nagpur,

Through: -

Dr. S.P. Raut
HOD, Civil Engg.
YCCE, Nagpur.

Dr. Ujwalla Gawande
Dean, R and D
YCCE, Nagpur.

Cash Memo

नकद पत्र

Sold to क्रेता

Vaishali Mendhe

YCEE, Nagpur

23/8/2022

No. क्रमांक

Date तिथि

QNTY. संख्या	PARTICULARS विवरण	RATE दर	AMOUNT रकम	
			₹	P.
88	स्टील		2500/-	
Thank you! धन्यवाद! E. & O. E. भूल चूक लेनी देनी।		TOTAL जोड़	2500/-	

H. R. Steel Fabrication
Hingna Road, Nagpur
M.: 9371941799, 9579358299

JHIL-MIL®

✓ बिका हुआ माल दोबारा वापिस नहीं होगा।
 ✓ Goods once sold will not be taken back.

[Signature]
 Signature हस्ताक्षर



CASH/ CREDIT MEMO

SONAL BOOKS & STATIONERS

Plot No. 67, Shop No. - 5, Swami Vistar Apartment, Trimurti Nagar, Nagpur. 9665998002
ALL KINDS OF STATIONERY, SCHOOL & ENGINEERING BOOKS & DRAWING MATERIAL SUPPLIER

No. **1824**

Date : 26/09/2022

M/s. Vaishali Mendhe Y.C.C.E. Nagpur

Sr. No.	Particulars	Qty.	Rate	Amount	
				Rs.	Ps
	Eraser	2NO	10/-	20	00
	Marker pen	2NO	28/-	56	00
TOTAL				76	00

Goods once sold will not be taken back
E. & O. E.

For SONAL BOOKS & STATIONERS

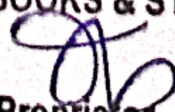
Proprietor

Tax Invoice

Parshwa Acrylics G-10, Manavi Arcade, Rajendra Nagar Opp. Hingna Octori, Hingna Road Nagpur-440036 Cell No - 9822203680 GSTIN/UIN : 27ADCPJ5851H1ZJ State Name : Maharashtra, Code : 27 E-Mail : parshwaacrylics@gmail.com Buyer VAISHALI MENDHE NAGPUR State Name : Maharashtra, Code : 27 Place of Supply : Maharashtra	Invoice No. 131 Supplier's Ref.	Dated 24-Sep-2022 Other Reference(s)
	Buyer's Order No.	Dated

Sl No	Description of Goods	HSN/SAC	GST Rate	Quantity	Rate	per	Amount
1	Acrylic Sheet CUTTING PCS	3920	18 %	3 Nos	300.00	Nos	900.00
	OUTPUT CGST						81.00
	OUTPUT SGST						81.00
Total				3 Nos			1,062.00 Rs

Amount Chargeable (in words)

One Thousand Sixty Two Rupees Only

E. & O.E

HSN/SAC	Taxable Value	Central Tax		State Tax		Total Tax Amount
		Rate	Amount	Rate	Amount	
3920	900.00	9%	81.00	9%	81.00	162.00
996515		9%		9%		
Total	900.00		81.00		81.00	162.00

Tax Amount (in words) : **One Hundred Sixty Two Rupees Only**

Company's Bank Details

Bank Name : **Union Bank of India (Current A/c)**
 A/c No. : **479001010250076**
 Branch & IFS Code : **TELECOMNAGAR & UBIN0547905**

Company's PAN : **ADCPJ5851H**

Declaration

We declare that this invoice shows the actual price of the goods described and that all particulars are true and correct.

for Parshwa Acrylics



SUBJECT TO NAGPUR JURISDICTION

This is a Computer Generated Invoice

Yeshwantrao Chavan College of Engineering, Nagpur

FORM OF UTILIZATION CERTIFICATE

UTILIZATION CERTIFICATE FOR THE YEAR 2021-22 in respect of Non-recurring/Recurring for seed Money form the institute

1. Name of the Scheme : Innovative Experimental Setup
2. Title of the project: Hardware Experimental Setup to Control and Analyse Signal in Cellular Phone
3. Name of Principal Investigator: Dr. Prabhakar Dorge
4. Name of Co-Principal Investigator (If Any):
5. Sanction Letter No.: YCCE/R and D Cell/2021-22/569 Dt. 16/04/2022
6. Amount Sanctioned: Non recurring: 18,500/- Recurring: NIL
Total Amount Sanctioned: 18,500/-
7. Actual expenditure : Non Recurring: 15,900/- Recurring: NIL
Total Expenditure (Actual): 15,900/-

Certified that the amount of Rs. 15,900/- has been utilised under Innovative Experimental Set up scheme.

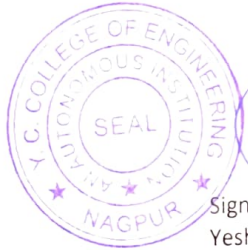

Signature of Finance Officer
Yeshwantrao Chavan College of Engineering
Wanadongri, Hingna Road
Nagpur-441110



Signature of Head of the Institute
Dr. U. P. Waghe, Principal
Yeshwantrao Chavan College of Engineering
Wanadongri, Hingna Road
Nagpur-441110
Principal
Yeshwantrao Chavan
College of Engineering
Wanadongri Hingna Road
NAGPUR-441110



Report

1. Name of the Scheme : Innovative Experimental Setup
2. Title of the project: Hardware experimental setup to control and analyse signals in cellular phone
3. Name of Principal Investigator: Dr. Prabhakar D. Dorge
4. Name of Co-Principal Investigator (If Any): NIL
5. Sanction Letter No.: YCCE/R and D Cell/2021-22/569
6. Details of Proposal

(Introduction, Working Principal with Circuit Diagram/Block diagram, Results analysis with photographs and conclusion)

Various mobile phones have different concepts and design on every aspect, but the methods and operational flow are all exactly the same. It differs on how and what certain IC chips are used and installed to a certain mobile phone circuitry. There are many sub-divisions of the electronic circuitry in mobile phone. In real world it is very difficult to study each section on the real time mobile phone. Also how to insert and identify various errors in the cellular signals that can be studied by using this hardware setup.

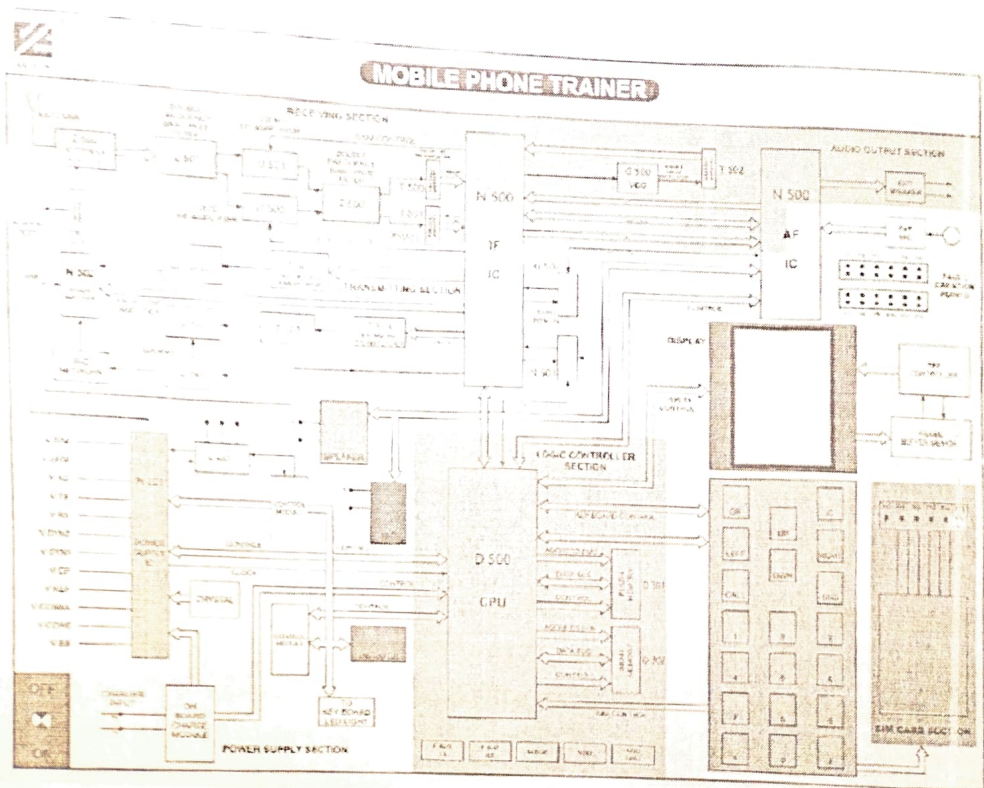

Mobile Phone Trainer kit has capability of full duplex mobile communication. Provides basic theory and working fundamentals of a 2G hand set based on the NOKIA 3310/3315. This trainer kit designed with a view to provide network, power supply, charging ik user interface circuits for their prail.1 and theoretical study based on NOKIA 3310/3315.

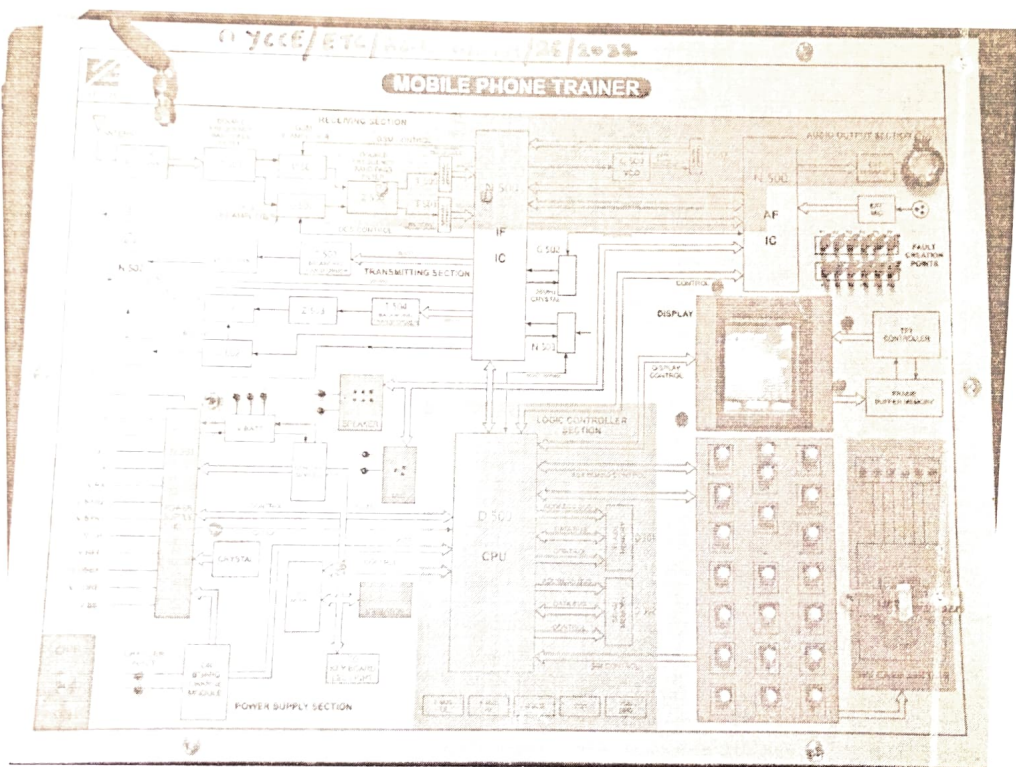

There are many fault switches and test points on this kit. Here we have inserted many faults. Also we have identified the faults in various sections on the mobile trainer kit. To understand the concepts of mixing of errors in the cellular signals, we insert some noise and identified the error location. Also we studied that how to introduce faults related to speaker, battery, mike, etc. on this hardware kit. Also we have studied the effect of above said fault during signals transmission and reception.

7. Applications where the product/Setup used for:

The mobile phone trainer kit has many applications in the field of wireless communication. Currently we are using this hardware setup in digital communication and electronic workshop labs to conduct some experiments based on cellular phone signals. The above said hardware kit can be used in various courses which are based on wireless communication in UG as well as PG courses of Electronics and Telecommunication engineering.

Dr. P. W. Royt

Dr. D. R. Rhojey

Dr. M. S. Narbawat

VINAMRA ENTERPRISES

9, Shyam Nagar-6, Benad Road, Jaipur-302040
 GSTIN/UIN: OSBAQPS6792E1ZX
 State Name: Rajasthan, Code: 08
 Contact: +91-9414733271, +91-8764159732
 Mail: vinamra.enterprises@gmail.com
 Website: www.vindia.co.in

Billed To:

Yashwantrao Chavan College of engineering
 Hingna road Wanadongri
 Nagpur - 441110

Mobile-9860455757 (Dr P. D. Dorje, Assit. Professor)

Email: nyssrushi12@gmail.com, pravinboinwar@gmail.com
 ajayd_deshmukh@rediffmail.com

TAX INVOICE

Invoice No. 005 Date 02-06-2022
 Reverse Charge No Buyer's Order
 Reference Order Date
 Delivery Note Transportation Mode
 Mode of Payment Way Bill no.
 Destination Other Reference

Shipped To:

Yashwantrao Chavan College of engineering
 Hingna road Wanadongri
 Nagpur - 441110

Mobile-9860455757 (Dr P. D. Dorje, Assit. Professor)

Email: nyssrushi12@gmail.com, pravinboinwar@gmail.com
 ajayd_deshmukh@rediffmail.com

Sr. No.	Description of Goods	HSN	Qty	Per	Rate	Taxable Amount	IGST %	Amount	SGST %	Amount	CGST %	Amount	Total
1	Mobile Phone Trainer	9023	1	SET	12500.00	12500.00	18	2250.00					14750.00

Freight and Forwarding
 Other Charges
 Round Off

Total

1	12500.00	2250.00	0.00	0.00	14750.00
---	----------	---------	------	------	----------

GST Detail

Total GST	IGST	SGST	CGST
2250.00	2250.00	0.00	0.00

Total Invoice Value in Words and Figures

Rs. Fourteen Thousand Seven Hundred Fifty Only

14750.00

Terms & Conditions:-

1. Goods once sold shall not be taken back
2. Our responsibility ceases as soon as material leave our premises
3. Materials dispatched at buyer's risk
4. Warranty (if any) does not include physical damage, damage during shipping, Burn, mishandling of the Product and also not applicable in any such circumstance which is not in our control
5. Any claim regarding the material rejection should be intimated to us within 7 days from the date of invoice, otherwise no claims shall be entertained later.
6. Any discrepancy what soever out of invoice will lapse unless raised in writing in 48 hours from the receipt of the invoice.
7. All disputes subject to Jaipur Jurisdiction only
8. Standard Force Majeure clause applies

 For VINAMRA ENTERPRISES
 (Authorized Signature)

This is Computer Generated Invoice

paytm

Payment Successful

₹ 1,150



Rupees One Thousand One Hundred Fifty Only

To: Xpressbees

payphi.xpressbeesupi@icici



From: Prabhakar Domaji Dorge

State Bank Of India A/c XX 5485



UPI Ref. No: 2171259 43824

12:29 PM, 20 Jun 2022

POWERED BY
UPI
UNIFIED PAYMENTS INTERFACE

To:**DR. P.D.DORGE**

YASHWANTRAO CHAVAN COLLEGE OF
ENGINEERING HINGNA ROAD,
WANADONGRI, NAGPUR, , NAGPUR,
Maharashtra, India - 441110

MOBILE NO: 9860455757

Fwd Destination Code: C/S-37/1B/110

XPRESSBEES[®]
delivering happiness

Order Date: Jun 03, 2022

Invoice No: 123456789123



123456789123

COD
₹1150

XPRESSBESS



14507822099999

SKU	Item Name	Qty.	Amount
N/A	AUTO PARTS	1	₹1150
	Order Total		₹1150

Yeshwantrao Chavan College of Engineering, Nagpur

FORM OF UTILIZATION CERTIFICATE

UTILIZATION CERTIFICATE FOR THE YEAR 2021-22 in respect of Non-recurring/Recurring for seed Money form the institute

1. Name of the Scheme : Innovative Experimental Setup
2. Title of the project: Adsorbent Containing Filer (ACF)
3. Name of Principal Investigator: Rajesh Bhagat
4. Name of Co-Principal Investigator (If Any):
5. Sanction Letter No.: YCCE/R and D Cell/2021-22/571 Dt. 16/04/2022
6. Amount Sanctioned: Non recurring: 15,500/- Recurring: NIL
Total Amount Sanctioned: 15,500/-
7. Actual expenditure : Non Recurring: 16,200/- Recurring: NIL
Total Expenditure (Actual): 16,200/-

Certified that the amount of Rs. 16,200/- has been utilised under Innovative Experimental Set up scheme.

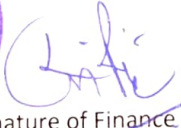

Signature of Finance Officer
Yeshwantrao Chavan College of Engineering
Wanadongri, Hingna Road
Nagpur-441110



Signature of Head of the Institute
Dr. U. P. Waghe, Principal
Yeshwantrao Chavan College of Engineering
Wanadongri, Hingna Road
Nagpur-441110

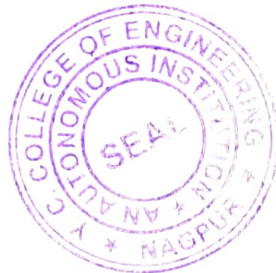

Principal
Yeshwantrao Chavan
College of Engineering
Wanadongri Hingna Road
NAGPUR-441110

Report

1. Name of the Scheme : In-house Scheme of Innovative Experimental Research
2. Title of the project: Adsorbent Containing Filter (ACF)
3. Name of Principal Investigator: Mr. Rajesh Bhagat
4. Name of Co-Principal Investigator (If Any): NA
5. Sanction Letter No.: YCCE/R and D Cell/2021-22/571
6. Details of Proposal :-

Introduction- ACF is a filter containing agricultural based adsorbents, which is a modified design of sand filter. The adsorbent developed from agricultural waste is used below the layer of sand and above the fine aggregate to treat the industrial wastewater. Increase in depth of adsorbent layer advisable if better quality of effluent is required. Four adsorbents are used prepared from four different agricultural wastes (Pigeon Pea Husk, Rice Husk, Wheat Husk & Soya Bean Husk) in ACF.

Working Principal- It is a vertically down flow filter. Working to similar to sand filter. As aerobic condition prevails at each layer there is no unpleasant odor and no anoxic conditions. This filter is efficient to remove heavy metals from industrial wastewater. Adsorbent layer is used in place of other media layer because it is better to remove heavy metals.

Results analysis with photographs- ACF is unit of iron and plastic framework was fabricated. This framework was then installed at Water Supply and Sanitary Engineering Lab. YCCE, Nagpur. Filter made up from acrylic pipe have dimension of 60 cm in height and 10 cm in diameter.

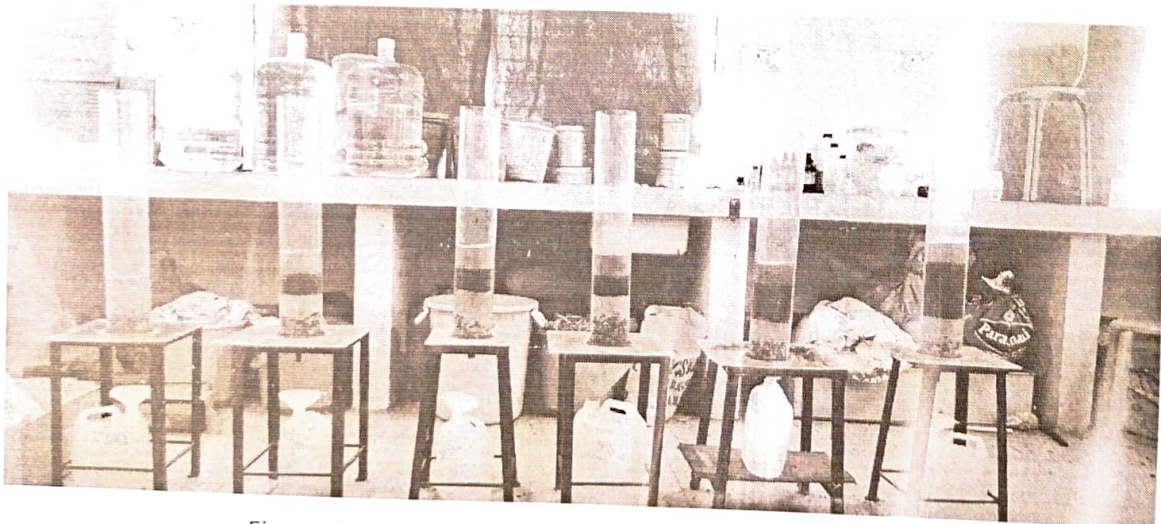

Figure 1: New Innovative Experimental Filter Unit Setup

Table 1: Removal of Heavy Metal Ni by Prepared Adsorbents using as Filter Media.

Adsorbents Prepared from	Initial Ni Conce. (mg/lit)	Cycle 1	Cycle 2	Cycle 3	Cycle 4	Cycle 5	Removal Efficiency (%)
Rice Husk	6 mg/lit	4.4 mg/lit	2.6 mg/lit	1.85 mg/lit	1.84 mg/lit	1.83 mg/lit	69.17%
Wheat Husk	6 mg/lit	4.25 mg/lit	2.4 mg/lit	1.44 mg/lit	1.43 mg/lit	1.42 mg/lit	76.13%
Soyabean Husk	6 mg/lit	4.5 mg/lit	2.75 mg/lit	1.80 mg/lit	1.79 mg/lit	1.78 mg/lit	70%

Conclusion- The results show that prepared adsorbent from agricultural waste is effective in the removal of Nickel from aqueous solution. Wheat husk gives better results as compared rice & soybean husk, all three materials can be used effectively for the process of adsorption remove the heavy metals from the industrial waste water.

7. Applications where the product/Setup used for:

This product/setup is useful for industrial wastewater treatment where heavy metal concentration is more and need to lower down the same as per requirements of effluent standards. The above agricultural wastes used for adsorbent development are readily available everywhere/nearby in abundant quantity. The new innovative experimental setup and its working is demonstrated to seventh semester students to explain wastewater treatment technology for the subject PE-IV Wastewater Treatment.



Dr. S. R. Khandeshwar

Expert & Professor,
CED, YCCE, Nagpur



Dr. S. V. Ambekar

Expert & Professor,
CED, YCCE, Nagpur



Dr. S. P. Raut

HOD, Civil Engg.,
YCCE, Nagpur

Nagar Yuwak Shikshan Sanstha's
Yeshwantrao Chavan College of Engineering

(An Autonomous Institution affiliated to Rashtrasant Tukadoji Maharaj Nagpur University)

Hingna Road, Wanadongri, Nagpur - 441 110

Ph - 07104-237919, 234623, 329249, 329250 Fax - 07104-232376, Website: www.ycce.edu

NOTE

Date: July 21, 2022.

Subject: - Settlement of Purchasing for New Experimental Setup under In-house Scheme of Innovative Experimental Research.

With reference to the above subject, the accessories are purchased to develop the new experimental setup (Adsorbent Containing Filter) after approval of financial assistance of 15500/- from committee for the proposal under In-house Scheme of Innovative Experimental Research.

Sr. No.	Name of Item Goods	Quantity	Rate	Amount in Rs.
1	Four Legs MS Stool (Weight - 38.40Kg) Invoice No. 150	08 Nos. (Weight - 38.40Kg)	90.00	3456.00
2	90 x 600 x 3 mm Acrylic pipe 118 x 118 Acrylic Sheet Invoice No. 158 Dated 11 May 2022	04 04	1050.00 GST@18% 150.00 GST@18%	5664.00
3	90 x 600 x 3 mm Acrylic pipe 118 x 118 Acrylic Sheet Invoice No. 217 Dated 28 May 2022	05 05	1050.00 GST@18% 150.00 GST@18%	7080.00
			Total	16200.00

Expenditure Incurred - Rs. 16200 -

Proposal Approved by Committee - Rs. 15500 -

It is therefore requested to sanction the expenditure **15500.00** (Rs. Fifteen Thousand Five Hundred Only).

Mr. R. M. Bhagat

Department of Civil Engg

Submitted to,

Principal, YCCE, Nagpur.

Through:-

HOD, Civil Engg.
YCCE, Nagpur.

Dr. Ujwala Gawande
Dean, R and D

For NA
G. S. Gawande
21/7/22
Acctt Sect

मेमो

॥ जय गजानन ॥

सोश
नो 9923611538

शक्ति फेब्रीकेशन वर्क्स

इंडर कॉलरी नं 6, बस स्टॉप काठ्डी

हमारे यहाँ ग्रील गेट, कुलर, बियान, पेटी, बेल गेट, आदी आर्डर से बनाये जाते हैं।

नाम <u>लाज गी. गी</u>	बिल नं. <u>450</u>
<u>इलाहाबाद</u>	दिनांक <u>12/6/22</u>

अ क्र	विवरण	वजन नया	रेट	रकम
	<u>12 x 12 x 15</u> <u>2 फुट - इलाहाबाद</u>	<u>38400</u>	<u>90%</u>	<u>345600</u>
	Y.C.C.C. Contract Stamp <u>Contract No 278</u> <u>Contract Date 12/6/2022</u> <u>Signature</u> <u>Name</u>			
	<u>धन्यवाद!</u>		टोटल	<u>345600</u>

अक्षरों में रुपये _____

12/6/22
तर्फ : शक्ति फेब्रीकेशन वर्क्स

Tax Invoice

Industrial Plastics & Insulation (20-21)

Hashmi Tower, Opp. Masjid
Chota Loharpura, Near Fawara
Chowk, Gandhibagh Nagpur-18
GSTIN/UIN : 27AABF11768G1ZE
State Name : Maharashtra, Code : 27
Contact : 8999521738 , 922522392
E-Mail : industrialplasticngp@gmail.com

Invoice No : 158
Dated : 11-May-22
Delivery Note : 2646
Mode/Terms of Payment : Cash
Reference No. & Date :
Other References :

Buyer (Bill to)
Principle of YCCE, Nagpur
Nagpur
Mobile No : 7104242620
State Name : Maharashtra Code : 27

Buyer's Order No :
Dated :
Dispatch Doc No :
Delivery Note Date : 11-May-22
Dispatched through :
Destination :
Terms of Delivery :

Sl	Description of Goods	HSN/SAC	Quantity	Rate	per	Amount
1	90 x 600x3mm Acrylic Pipe	3920	4 NOS	1,050.00	NOS	4,200.00
2	Acrylic Sheet 1x7' Clear	39205111	4 NOS	150.00	NOS	600.00
						4,800.00
OUTPUT CGST					9 %	432.00
OUTPUT SGST					9 %	432.00
			Total	8 NOS		₹ 5,664.00

F.C.C.E.
Gate Entry Stamp
Date: 21/07/22
Security: 358
Signature: [Handwritten Signature]

Amount Chargeable (in words)

INR Five Thousand Six Hundred Sixty Four Only

E. & O.E

HSN/SAC	Taxable Value	Central Tax		State Tax		Total
		Rate	Amount	Rate	Amount	Tax Amount
3920	4,200.00	9%	378.00	9%	378.00	756.00
39205111	600.00	9%	54.00	9%	54.00	108.00
Total	4,800.00		432.00		432.00	864.00

Tax Amount (in words) : **INR Eight Hundred Sixty Four Only**

Company's PAN : **AABF11768G**

Company's Bank Details
Bank Name : **ICICI Bank**
A/c No : **146305000992**
Branch & IFS Code : **ITWARI BRANCH & ICIC0001463**
for Industrial Plastics & Insulation (20-21)

Declaration
We declare that this invoice shows the actual price of the goods described and that all particulars are true and correct

[Handwritten Signature]
Authorised Signatory

Tax Invoice

Industrial Plastics & Insulation (20-21)

Hashmi Tower, Opp. Masjid
 Chota Loharpura, Near Fawara
 Chowk, Gandhibagh Nagpur-18
 GSTIN/UIN: 27AABF11768G1ZE
 State Name: Maharashtra Code: 27
 Contact: 8999521738, 9225222392
 E-Mail: industrialplasticnagpur@gmail.com

Buyer (Bill to)
Principle of YCCE, Nagpur
 Nagpur
 Mobile No: 7104242620
 State Name: Maharashtra Code: 27

Invoice No 212	Dated 28-May-22
Delivery Note	Mode/Terms of Payment Cash
Reference No. & Date	Other References
Buyer's Order No	Dated
Dispatch Doc No	Delivery Note Date
Dispatched through	Destination
Terms of Delivery	

S	Description of Goods	HSN/SAC	Quantity	Rate	per	Amount
1	90 x 600x3mm Acrylic Pipe	3920	5 NOS	1,050.00	NOS	5,250.00
2	Acrylic Sheet 1 x 1 Clear	39205111	5 NOS	150.00	NOS	750.00
						6,000.00
OUTPUT CGST					9 %	540.00
OUTPUT SGST					9 %	540.00
Total						10 NOS
						₹ 7,080.00

Y.C.C.E.
 Gate Entry Stamp
 Date: 28/05/22
 Recd: [Signature]

Amount Chargeable (in words)
INR Seven Thousand Eighty Only

HSN/SAC	Taxable Value	Central Tax		State Tax		Total Tax Amount
		Rate	Amount	Rate	Amount	
3920	5,250.00	9%	472.50	9%	472.50	945.00
39205111	750.00	9%	67.50	9%	67.50	135.00
Total	6,000.00		540.00		540.00	1,080.00

Tax Amount (in words) : **INR One Thousand Eighty Only**

Company's PAN: **AABF11768G**

Company's Bank Details
 Bank Name: **ICICI Bank**
 A/c No: **146305000992**
 Branch & IFS Code: **ITWARI BRANCH & ICIC0001463**
 for Industrial Plastics & Insulation (20-21)

Declaration
 We declare that this invoice shows the actual price of the goods described and that all particulars are true and correct

[Signature]
 Authorised Signatory

This is a Computer Generated Invoice

Yeshwantrao Chavan College of Engineering, Nagpur

FORM OF UTILIZATION CERTIFICATE

UTILIZATION CERTIFICATE FOR THE YEAR 2021-22 in respect of Non-recurring/Recurring for seed Money form the institute

1. Name of the Scheme : Innovative Minor Patentable Product
2. Title of the project: Development of Power Factor Correction Device for Residential Load
3. Name of Principal Investigator: Atul Lihhare
4. Name of Co-Principal Investigator (If Any): Pranya Shete and Dr. S. G. Kadwande
5. Sanction Letter No.: YCCE/R and D Cell/2021-22/ Dt. 16/09/2021
6. Amount Sanctioned: Non recurring: 6,100/- Recurring: 5000/-
Total Amount Sanctioned: 11,100/-
7. Actual expenditure : Non Recurring: 5,592/- Recurring: NIL
Total Expenditure (Actual): 5,592/-

Certified that the amount of Rs. 5,592/- has been utilised under Innovative Minor Patentable Product Scheme.

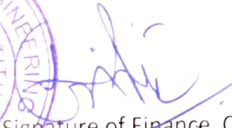

Signature of Finance Officer
Yeshwantrao Chavan College of Engineering
Wanadongri, Hingna Road
Nagpur-441110



Signature of Head of the Institute
Dr. U. P. Waghe, Principal
Yeshwantrao Chavan College of Engineering
Wanadongri, Hingna Road
Nagpur-441110

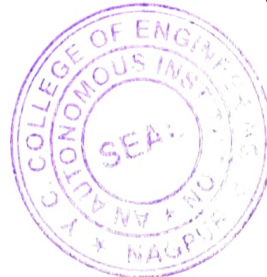

Principal
Yeshwantrao Chavan
College of Engineering
Wanadongri Hingna Road
NAGPUR-441110

Report

1. Name of the Scheme : Innovative minor patentable product
2. Title of the project: **Development of Power Factor Correction device for residential load.**
3. Name of Principal Investigator: Mr.A.S.Lilhare
4. Name of Co-Principal Investigator (If Any): Mr.P.S.Shete, Dr.S.G.Kadwane
5. Sanction Letter No.: YCCE/R&D CELL/2021-22/
6. Details of Proposal

I. Introduction

Today, we are observing an ever-increasing demand for electrical energy if we can contribute a smaller device to improve power factor and reduce the loss in any sector then it can give a little boost to the idea of saving and using the energy that we have more effectively and efficiently. Generally, the use of inductive load in the system increases the reactive load in the system. So that current lag behind the voltage, it occurs lagging power factor due to this the efficiency of the system get reduces and electricity bill gets increase [1]. Also, due to significant phase difference between voltage and current at the load terminal, system draw a power at low power factor, it means it also have a distorted waveform.

So many methods are developed now a days in order to monitor and control the power factor of residential load. In [2], one of the most important converter is used for water pumping application which is further utilized for the development power factor correction in water pumping application of residential load as mentioned in [3].

A well system is developed to achieve high power factor in single phase system by operating in continuous conduction mode which work on the principal of avaregae current mode control. In [5], a microcontroller device is used which ensure automatic correction of the power factor without operator. The triac based power factor corrector for singlr phase domestic load is proposed in [6]. Other approach [7] is to use a PFC device for each load means in multiple way in order to acieve a desired power qualityin the area of residential load. Instaed of above a concept of filter and capacitor compensator (MPF/C) Green Plug is used for effective energy conservation, for 2 phase, 3 wire household load [8]. An open source energy monitoring library were implemented in order to monitor the energy consumption of a system and automatically improve its power factor [9].

With above discussion , it observed that there is still some scope to work in the area of residential load for power factor improvement. There is need of development of cheper and effective power factor correction device which will be able to maintain unity power factor at residential load. This paper deals with automatic monitoring and improvement of power factor with the help of embedded system. It simple consist of Arduino board , capacitor bank and relays. Instead of CT and PT , voltage and current sensors are used. This sensors are

$$Z = R + jX_L \quad \dots(1)$$

$$Z = 10 + j(2\pi \times 50 \times 0.31831) = 100.49 \angle 84.28^\circ \Omega$$

The current drawn by the load is

$$I = \frac{V}{Z} \quad \dots(2)$$

$$I = \frac{220 \angle 0^\circ}{100.49 \angle 84.28^\circ \Omega} = 2.19 \angle -84.28^\circ A$$

Nature of the current is lagging as the phase angle is negative. Similarly, the complex power of the load is calculated as

$$S = VI^* \quad \dots(3)$$

$$S = 220 \angle 0^\circ \times 2.19 \angle -84.28^\circ = 481.8 \angle -84.28^\circ VA$$

$$S = 48.02 - j479.401 VA$$

Once complex power is evaluated, power factor can be calculated as shown in equation in(4).

$$p.f = \frac{P}{S} = \frac{48.02}{481.8} = 0.0996 \quad \dots(4)$$

B. Capacitive bank for Unity power factor operation

For unity power factor operation, the complex power should be equal to active power which means that total reactive power drawn by the system is zero. By submitting the imaginary part of load current is zero, the power factor of the system can be improved. So reactive power required to fed by capacitor is

$$Q_C = 479.401 Var$$

With the help of equation (5), capacitive reactance can be calculated, once the value of reactance known, required value of capacitor is determined from equation (6).

$$Q_C = \frac{V^2}{X_C} \quad \dots(5)$$

$$X_C = \frac{V^2}{Q_C} = \frac{220^2}{479.401} = 100.96 \Omega$$

$$X_C = \frac{1}{2\pi f C} \quad \dots(6)$$

$$C = \frac{1}{2\pi f X_C} = \frac{1}{2\pi \times 50 \times 100.96} = 31.52 \mu F$$

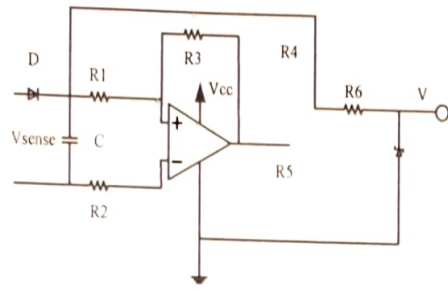

Fig.4 Current sensing circuit for PFC Unit for residential load

Similarly, bias resistor sensed the current and convert it into voltage as controller only work on voltage signal. This generated voltage is passed through zero crossing detector so that zero crossing from positive half cycle to negative half cycle can be detected. This generated signal is then fed to controller as sense current signal as shown in figure 4.

C. Controller circuit

A microcontroller is the heart of the system. It will sense the phasor term of voltage and current from sensing unit. After receiving information it will manipulate phase angle and phase difference between this two waves. This information information display on LCD screen. A microncontroller detect the angle between current and voltage signal and Once angle information is confirmed , a value of power factor is obtained. Depend upon the power factor value , controller will take a decision of switch in or out of capacitor in such way that the system power factor will remain at unity value.

D. Relay Driver Circuit

Relay driver as shown in figure 5, ensure connection or disconnection of capacitor in the circuit. Relay work is totally depend on the signal send by the controller. It means relay on its own can not controlled the switching of capacitor in the system.

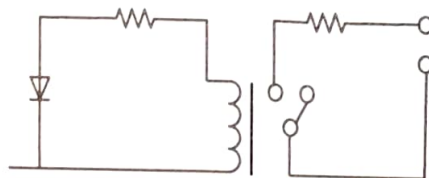

Fig.5 Relay driver circuit for PFC Unit for residential load

V. Simulation result of the proposed system

The said system is tested with the help MATLAB software. By considering the all parameter as mentioned in above parameter design , the results are obtained.

Figure 6 shows a result for supply voltage and current. At initial stage, due to inductive load , system draw a current which is lag to the supply voltage as shown in figure 7. This phase angle is sensed by the PFC unit , so it switch on the capacitor in circuit at 0.5 sec in order to achieve the unity power factor as shown in figure 6. It can be observe that , magnitude of current is decreased and its in phase with the supply voltage as shown in figure 8.

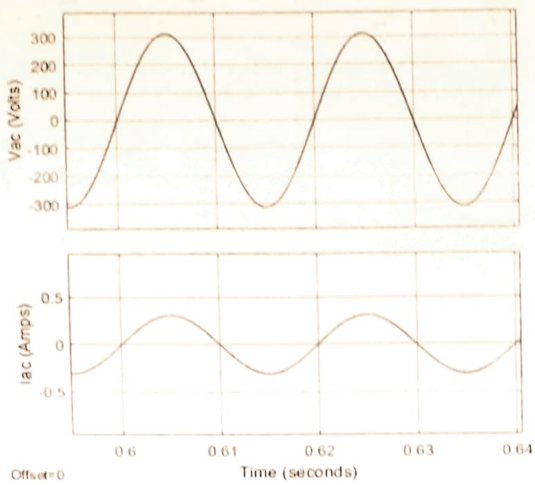

Fig.8 Supply voltage and In phase current of PFC Unit for residential load

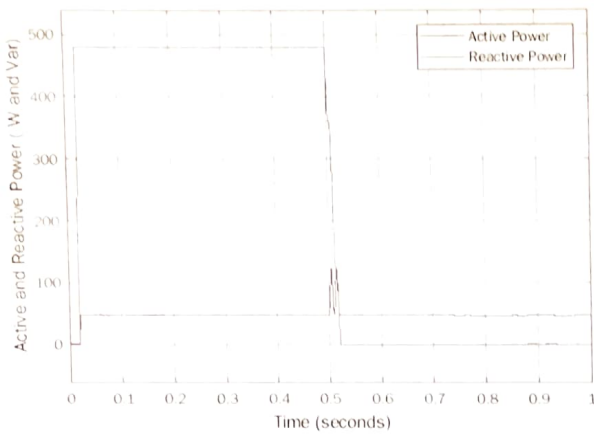

Fig.9 Active and Reactive power of PFC Unit for residential load

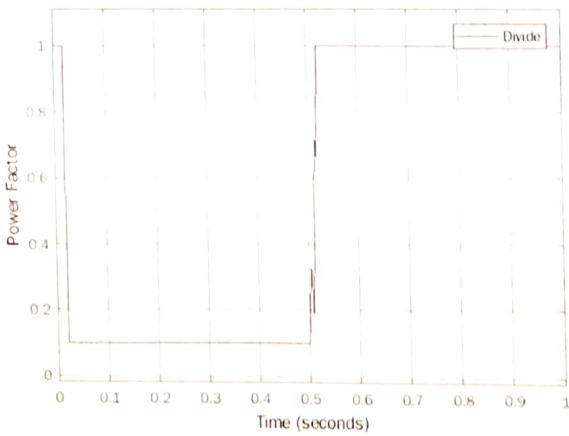

Fig.10 Power factor of PFC Unit for residential load

7. **Applications where the product/Setup used for:**

Our power factor correction device will take a care of unity power factor at residential load so that rated amount of supply voltage and supply current will maintain. This device also help to improve the efficiency of the overall system, at same time it also help to reduce the electricity bill. After switching ON or OFF of capacitor bank in the system, the surge in voltage appears so this surge in voltage should not be cross its range in such a way that the system will remain unaffected. so therefore surge protection is also provided in this devices.



Mr. P. S. Shete
Co-Principal Investigator



Dr. S. G. Kadwane
Co-Principal Investigator

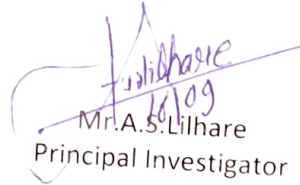

Mr. A. S. Lilhare
Principal Investigator

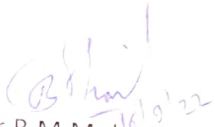

Dr. R. M. Moharil
Expert Member 01

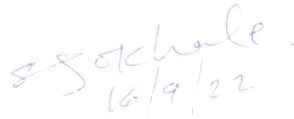

Dr. S. S. Gokhale
Expert Member 02

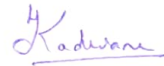

Dr. S. G. Kadwane
HoD, EL

**Head of Department
Electrical Engg.
Y.C.C.E., Nagpur**

SIDDHI

Siddhi Infotech Enterprises

Plot No.11/2, Bharat Mata Nagar
Area of Swagat Nagar, New Narsala
Nagpur-400 034
Mob No: 9028028301, 9765020820
E- mail:-info.siddhi10@gmail.com

TAX INVOICE 2021-22

To, The Principal Yeshwantrao Chavan College of Engineering Hingna Road, Wanadongri Nagpur - 441 110	Invoice No.: SIE/INV/21-22/47 Date:03/01/2022 D. M. No.: SIE/DC/21-22/47 Date: 03/01/2022 Buyer's PO NO: 808-YCCE/POHO/21-22/193 Dated: 21/12/2021 Date of handling PO:24/12/2021 GSTN NO.: 27DNUPS5374D1ZA
--	--

Contact Person: - HOD of the ETRX Dept.

S N	Description of Good	Units	HSN Code	Qty	Rate	Amount
1	ZMPT 101B AC single phase voltage sensor 250V	1 sets	8542	02	325	650
2	Current sensor module ACS712-20A		9031	02	200	400
3	Arduino Uno R-3		8473	01	590	590
4	IC7805 Voltage Regulator			06	10	60
5	Relay Module 5 Channel 5V SSR			01	1000	1000
6	ULN2003		8517	01	20	40
7	Capacitor Ceramic 101		8542	02	1	12
8	Capacitor Ceramic 102		8302	12	1	12
9	Capacitor Ceramic 103			12	1	12
10	Capacitor Ceramic 104			12	1	12
11	Capacitor 2.5MFD			14	1	14
12	Capacitor 4MFD			02	90	180
13	Capacitor 10MFD		8302	02	120	240
14	Center Tap transformer 18-0-18, 500mA			04	200	800
15	16*2 LCD display 18V			01	100	100
16	Multi stand wire 10mtr		8531	01	150	150
17	Teflon Tape			01	50	50
18	Diode 1N4007			01	250	250
				10	1	10

Bank Details: BANK :-PUNJAB NATIONAL BANK BRANCH : NANDANWAN, NAGPUR-400 009 A/c no:- 4608002100002636 RTGS/NEFT IFS CODE NO:- PUNB0460800	Total Amount	4570
	Taxable Value	4570
	Add CGST@9%	411.3
Certified that the particulars given above are true & correct Terms & Conditions of Sale 1. Goods once sold will not be accepted back 2. Interest @24% p. a. will be charged if payment not made in 15 days Subject to Nagpur Jurisdiction	Add SGST@9%	411.3
Amount (In Words): Five Thousand Five Hundred Ninety Two Only	Add IGST@18%	--
	Tax Amount GST	822.6
	Transportation Charges	200
	Total Value(Amt) (Round-up)	5,592



For SIDDHI INFOTECH ENTERPRISES

SIDDHI

Siddhi Infotech Enterprises

Plot No. 11/2, Bharat Mata Nagar
Area of Swagat Nagar, New Narsala
Nagpur-400 034

Mob. No: 9028028301, 9765020820
E- mail:-info.siddhi10@gmail.com

DELIVERY CHALLAN

Ref. No.: SIE/DC/21-22/47

Date: 03/01/2022

To,
The Principal
Yeshwantrao Chavan College of Engineering
Hingna Road, Wanadongri
Nagpur - 441 110

Contact Person: - HOD of the ΣE ETRX Dept.

Buyer's PO NO: 808-YCCE/POHO/21-22/193 Dt. 21/12/2021 Date of handling PO: 24/12/2021

S. N.	Particulars	Qty	Remark
1	ZMPT 101B AC single phase voltage sensor 250V	02	
2	Current sensor module ACS712-20A	02	
3	Arduino Uno R-3	01	
4	IC7805 Voltage Regulator	06	
5	Relay Module 8 Channel 5V SSR	01	
6	ULN2003	02	
7	Capacitor Ceramic 101	12	
8	Capacitor Ceramic 102	12	
9	Capacitor Ceramic 103	12	
10	Capacitor Ceramic 104	14	
11	Capacitor 2.5MFD	02	
12	Capacitor 4MFD	02	
13	Capacitor 10MFD	04	
14	Center Tap transformer 18-0-18, 500mA	01	
15	16*2 LCD display 18V	01	
16	Multi stand wire 10mtr	01	
17	Teflon Tape	01	
18	Diode IN4007	10	

RAN
03/01/22



FOR SIDDHI INFOTECH ENTERPRISES

Yeshwantrao Chavan College of Engineering, Nagpur

FORM OF UTILIZATION CERTIFICATE

UTILIZATION CERTIFICATE FOR THE YEAR 2021-22 in respect of Non-recurring/Recurring for seed Money form the institute

1. Name of the Scheme : Innovative Experimental Setup
2. Title of the project: Long Range Wireless communication Setup
3. Name of Principal Investigator: Dr. Pravin Zode
4. Name of Co-Principal Investigator (If Any):
5. Sanction Letter No.: YCCE/R and D Cell/2021-22/009 Dt. 27/08/2021
6. Amount Sanctioned: Non recurring: 37800/- Recurring: 3000/-
Total Amount Sanctioned: 40,800/-
7. Actual expenditure : Non Recurring: 31,270/- Recurring: NIL
Total Expenditure (Actual): 31,270/-

Certified that the amount of Rs. 31,270/- has been utilised under Innovative Experimental Set up scheme.

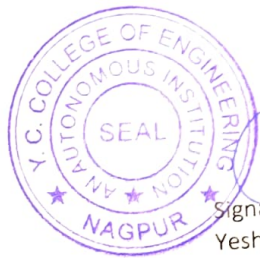

Signature of Finance Officer
Yeshwantrao Chavan College of Engineering
Wanadongri, Hingna Road
Nagpur-441110

Signature of Head of the Institute
Dr. U. P. Waghe, Principal
Yeshwantrao Chavan College of Engineering
Wanadongri, Hingna Road
Nagpur-441110

Principal
Yeshwantrao Chavan
College of Engineering
Wanadongri Hingna Road
NAGPUR-441110



Report

1. Name of the Scheme : **Innovative Experimental Setup**
2. Title of the project: **Long Range Wireless Communication Setup**
3. Name of Principal Investigator: **Dr. Pravin Zode**
4. Name of Co-Principal Investigator (If Any): ----
8. Sanction Letter No.: **YCCE/ R and D Cell / 2021-22 /009**
5. Details of Proposal

RFM XX Ultra-long Range Transceiver

The RFM XX W transceivers feature the LoRa long range modem that provides ultralong range spread spectrum communication and high interference immunity whilst minimizing current consumption

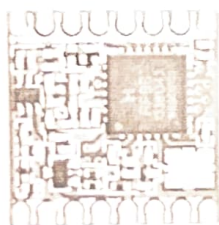

SX1262 LoRa HAT

This is a Raspberry Pi LoRa HAT based on SX1262, which covers the 915MHz frequency band. It allows data transmission up to 5km through the serial port

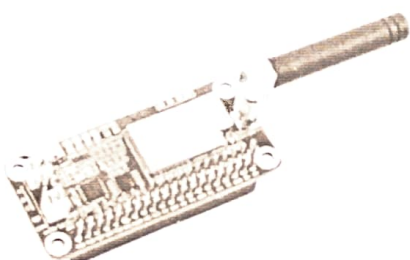

Photograph of setup

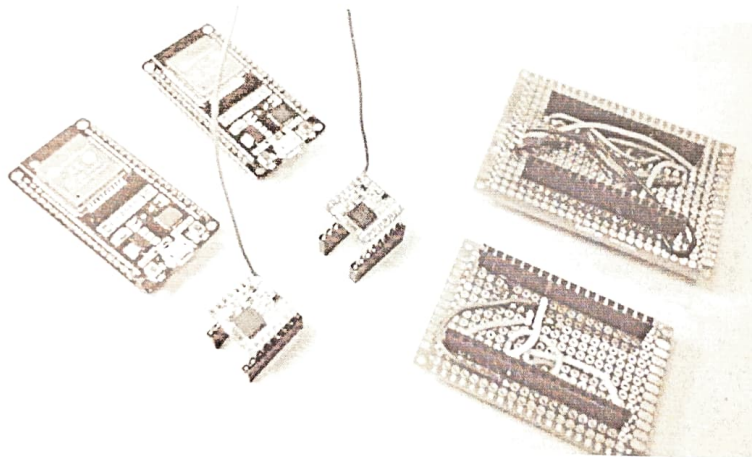
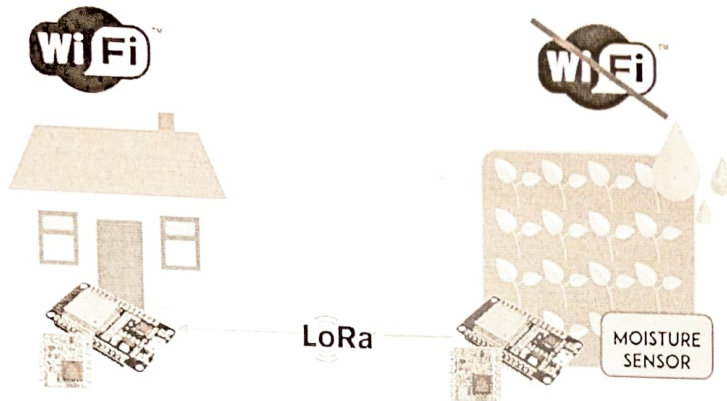

6. Applications where the product/Setup used for:

- Setup can be used in irrigation projects, smart cities
- Setup can be used for final year projects and research work

B. Bhat
Dr. R. D. Bhat
HOD (EE)

Prachi
Dr. V. S. Khodse

Prachi
Prachi Pabodkar



Department of Electronics Engineering

Date: 25/11/2021

Note

Kind Attention : **Mr. Rushi Baghel**

As per discussion and query raised, please find the attached revised sanctioned letter and revised purchase requirement

S. No	Particulars	Unit Price	Quantity	Total	Supplier
1 ✓	MKR WAN 1300 (Lora Connectivity)	3500	4	14000	Robo Studio
2 ✓	RFM 95 Ultra Long Range Transceiver	750	5	3750	Robo Studio
3 ✓	SX12622 Lora Hat for Raspberry Pi	1700	4	6800	Robo Studio
4	LoRA Gateway Sentirus RG 186			0	Not Required
5 ✓	RF Wireless Transmission 868 MHz	1950	3	5850	Robo Studio
6 ✓	Plastic Box 9 compartment	140	10	1400	Mavji L. Shah
7 ✓	Plastic Box 12 Compartment	145	10	1450	Mavji L. Shah
8 ✗	Platic Box No Compartment	55	24	1320	Mavji L. Shah
Total without GST				34570	
GST 18 %				6222.6	
Total including GST				40792.6	

Dr. R.D. Thakare
HoD, Electronics Engg

Dr. Pravin Zode
Asstt. Prof.

Yeshwantrao Chavan College of Engineering, Nagpur

FORM OF UTILIZATION CERTIFICATE

UTILIZATION CERTIFICATE FOR THE YEAR 2021-22 in respect of Non-recurring/Recurring for seed Money form the institute

- 1 Name of the Scheme : Innovative Experimental Setup
- 2 Title of the project: Installation of Automatic UPS System at Home (Demo Model)
- 3 Name of Principal Investigator: Atul Lilhare
- 4 Name of Co-Principal Investigator (If Any):
- 5 Sanction Letter No.: YCCE/R and D Cell/2021-22/1010 Dt. 27/08/2021
- 6 Amount Sanctioned: Non recurring: 10,700/- Recurring: 1000/-
Total Amount Sanctioned: 11,700/-
- 7 Actual expenditure : Non Recurring: 9,987/- Recurring: NIL
Total Expenditure (Actual): 9,987/-

Certified that the amount of Rs. 9,987/- has been utilised under Innovative Experimental Set up scheme



Signature of Finance Officer
Yeshwantrao Chavan College of Engineering
Wanadongri, Hingna Road
Nagpur-441110



Signature of Head of the Institute
Dr. U. P. Waghe, Principal
Yeshwantrao Chavan College of Engineering
Wanadongri, Hingna Road
Nagpur-441110
Principal
Yeshwantrao Chavan
College of Engineering
Wanadongri Hingna Road
NAGPUR-441110



Report

1. Name of the Scheme : Innovative experimental set up
2. Title of the project: **Installation of automatic UPS system at Home (Demo Model)**
3. Name of Principal Investigator:A.S.Lilhare
4. Name of Co-Principal Investigator (If Any):
8. Sanction Letter No.: YCCE/R&D CELL/2021-22/1010
5. Details of Proposal
(Introduction, Working Principal with Circuit Diagram/Block diagram, Results analysis with photographs and conclusion)

UPS means an uninterrupted power supply. Whenever an electrical power supply breakdown occurs. in such a condition quick power supply can be provided with the help of UPS along with batteries.

There is two basic UPS Inverter with batteries wiring connection at the home distribution board.

- Automatic UPS / Inverter with Two Wires
- Automatic UPS / Inverter Wiring with One Live Wire

Automatic UPS / Inverter Wiring with two Wires.

In this type of connection. the main supply is directly fed to the UPS. Whereas output of UPS is connected to the desired load as shown in fig 1.

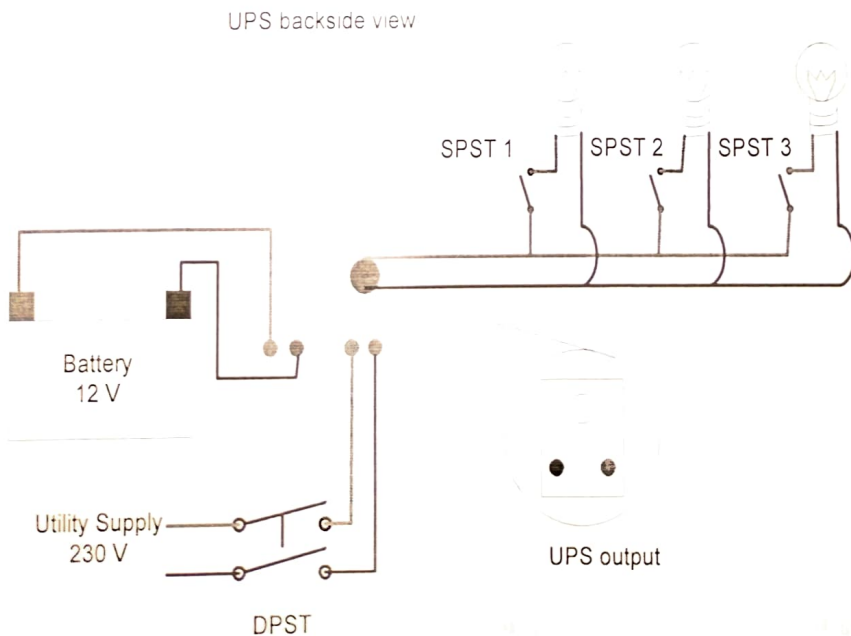

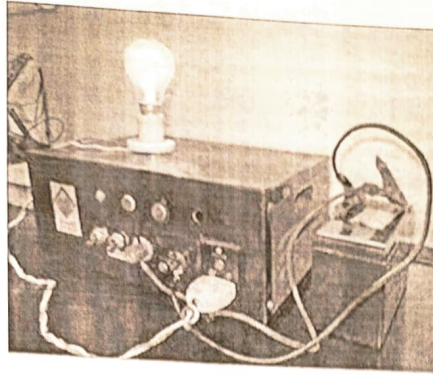

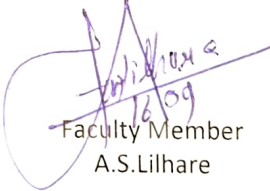

Experimentally performance of each power part as well as the complete UPS has been investigated

6. Applications where the product/Setup used for:
 - i. Experimental Set up
 - ii. Professional trainer kit
 - iii. Entrepreneurship scope in the sector of UPS Installation and service at Hospitals, Colleges etc.
 - iv. Scope for research in area of UPS topologies, circuit configurations, and different control techniques used in the UPS system.
 - v. Scope for research in area of Different hybrid energy source UPS system and new generation UPS system for smart grid and micro-grid.
 - vi.

Faculty Member
A.S.Lilhare

Expert 01
Dr.S.S.Gokhale

Expert 02
Dr.S.D.Patil

(Dr. S.G. Kadwane)
HoD,EL
Dr.S.G.Kadwane

GST INVOICE/CREDIT

COMPUTER & CARTRIDGE POINT

Address: ANAND NAGAR, BESIDES Dr. VYAS HOSPITAL,
NEAR SAKKARDARA POLICE STATION, NAGPUR-440009
Websites : www.computercartridgepoint.com
E-Mail : anurag1010guhe@gmail.com
GSTIN : 27AZMPG3447Q1ZO

Phone : 9860442828
9527442828

- * Deals in Computer, Laptop & Cartridge with Sales & Services
- * Cartridge Refilling
- * Data Recovery, CCTV Camera
- * All types of Computers, Laptops, Printers Accessories & Repairing

Buyer Name M/s Yeshwantrao Chavan College of Engineering Wanadongri Hingna YCCE Campus Nagpur GSTIN : Ph No.: 9325727688.9158888195	Invoice No. 6223 e-Way Bill No.	Date 24/09/2021
	Order No. YCCE/POHO/21-22106/519 D.M No.	Date 15/09/2021
	L.R. No.	Date 24/09/2021
Ship/Consignee Detail M/s GSTIN :	Transport	Payment Terms D.H.R. No. 115 DATE 24/09/21

S	PARTICULARS	MAKE	HSN	QTY.	UNIT	RATE	N.RATE	SGST%	CGST%	AMOUNT
1	PS 600 VA Zebronic	Zebroni	85412900	1	PCS	1675.00	1976.50	9.00	9.00	1675.00
										Add TRANSPORTATION 84.74

Certified that the items / Articles of Bill No. 6223 Dated 24/09/21 have been entered in the Stock on Page No.
Date 27/09/21 Signature of Store Keeper

Bill certified for payment of Rs 2077.74
- Authorised

GST% Taxable Amt. SGST CGST 0.00% 0.00 0.00 0.00 5.00% 0.00 0.00 0.00 12.00% 0.00 0.00 0.00 18.00% 1759.74 158.38 158.38 28.00% 0.00 0.00 0.00	Total Quantity 1 Bank Details The Chintnavispora Sahakar Bank Ltd Branch. Sakkardara, Nagpur A/C NO. : 005003005000036 IFSC : ICICI00TCSBL	GROSS AMOUNT 1759.74 DISCOUNT 0.00 Add SGST 158.38 Add CGST 158.38 CR/DR NOTE 0.00 Add 0.00 ROUND OFF 0.50
Current Outstanding : 861961.00 Rs. Two Thousand Seventy Seven Only		GRAND TOTAL 2077.00

Remark :
Terms & Conditions
 1. Goods once sold will not be taken back or exchanged.
 2. Bills not paid due date will attract 24% interest.
 3. All disputes subject to Jurisdiction only.
 4. Prescribed Sales Tax declaration will be given.
 5.
 6.
 24.9.21
 security

RECEIVER'S SIGNATURE
 Signature: [Handwritten Signature]
 Date: 24/09/21

For COMPUTER & CARTRIDGE POINT

 Authorised signatory

ADARSH TRADING COMPANY

P. R. No. 21/09/21

REG ADDRESS: WARD NO. 002, BEHIND SAVTA MANDIR, KALMESHWAR (M.S)-441501
 CORRESPONDENCE : PLOT NO 27 BEHIND GOVIND CELEBRATION LAWN PRAKASH NAGAR
 ZINGABAITAKLI NAGPUR
 PINCODE: 440030

EMAIL : atckalmeshwar@gmail.com
 TEL.:08275784059, M:08055212048

GST NO: 27CCMPP0902Q1Z2

Credit Memo

Tax Invoice

Billed to :
 M/s. : YASHWANTRAO CHAVHAN COLLEGE OF ENGG.
 Add. :

Inv. No : 674

Date : 17/09/2021

DN NO.: 704

Date : 17/09/2021

PO.NO: 518

PO.Date : 11/09/2021

HINGNA

State : 27-Maharashtra

GSTIN :

Sr.	PRODUCT NAME	UNIT	QTY	RATE	BASIC AMT.	CGST		SGST		IGST		TOTAL AMOUNT
						Rate	Amt.	Rate	Amt.	Rate	Amt.	
1	BATTERY 12V 65AH MAKE XNRAOM 85072000	NOS	1	4850.00	4850.00	14%	679.00	14%	679.00			620
<div style="border: 1px solid black; padding: 5px; margin: 10px;"> Certified that the items / Articals of Bill No. <u>674</u> Dated <u>17/9/21</u> have been entered in the Stock on Page No. _____ Date <u>24/09/21</u> Signature of Store Keeper <u>[Signature]</u> </div>												
<div style="text-align: center; margin: 10px;"> <p>certified for payments</p> <p>of Rs. <u>6358/-</u></p> <p><u>[Signature]</u> - Authority</p> </div>												
Sub Total :					1	4850.00						6

Amount In Words : Six Thousand Three Hundred Fifty Eight Only

Transportation : 15

BANK DETAILS:

BANK NAME: STATE BANK OF INDIA
 BANK BRANCH: C/O NATHE HOUSE MIDC ROAD KALMESHWAR
 BANK A/C NO: 34903040923
 BANK IFSC CODE: SBIN0011423

Round off :

Terms & Condition :

- Goods Once sold will not be taken back and goods are dispatched at byers risk. The Seller is not responsible for the losses shortage damage etc.
- Interest @ 24% p.a. will Be charged for delayed paymentes after due date.

GRAND TOTAL : 6358

NAGPUR

For ADARSH TRADING



(Authorised Signatory)

Receivers Signature & Stamp

Tax Invoice

Maheshwari Trading Company 20-21
 Central Avenue
 Near Punjab & Sindh Bank,
 Nagpur
 GSTIN/UIN: 27AACFM0341C1ZY
 State Name: Maharashtra, Code: 27
 E-Mail: mtcnpg@gmail.com

Invoice No. 0944	Dated 29-Sep-2021
Delivery Note 2791	Mode/Terms of Payment
Supplier's Ref 2791	Other Reference(s)
Buyer's Order No. PO. NO. YCCE/POHO/21-22/108	Dated 11-Sep-2021
Despatch Document No.	Delivery Note Date 29-Sep-2021
Despatched through	Destination
Terms of Delivery	

Buyer
YESHWANTRAO CHAVAN COLLEGE OF ENGG.
HINGNA ROAD, WANADONGRI
NAGPUR
 State Name: Maharashtra, Code: 27

D.P.R. No. **131**
16/10/21
D.P.R. No.

S	Description of Goods	HSN/SAC	Quantity	Rate	per	Disc %	Amount
1	M C B 16AMP 2 POLE	8536	1.000 NO.	300.00	NO.		300.00
2	WOODEN BOARD 10X12'	4421	1.000 NO.	75.00	NO.		75.00
3	BUTTON HOLDER	8536	3.000 NO.	20.00	NO.		60.00
4	PVC COPPER WIRE 1MM	8544	1 ROLL	800.00	ROLL		800.00
Certified that the items particulars of Bill No. 0944 Dated 29/09/21 have been entered in the Stock on Page No.							1,235.00
Freight (Outward) CGST SGST ROUND OFF							150.00 124.66 124.66 (-):0.32
Less:							
Total							₹ 1,634.00

Date **16/10/21** Signature of Store Keeper

Amount Chargeable (in words)
INR One Thousand Six Hundred Thirty Four Only

less Penalty **₹ 552** E & O E

HSN/SAC	Taxable Value	Central Tax Rate	Central Tax Amount	State Tax Rate	State Tax Amount	Total Tax Amount
8536	403.73	9%	36.34	9%	36.34	72.68
4421	84.11	9%	7.57	9%	7.57	15.14
8544	897.16	9%	80.75	9%	80.75	161.50
Total			124.66		124.66	249.32

Tax Amount (in words) **INR Two Hundred Forty Nine and Thirty Two paise Only**

Bill certified for payment
 of Rs. **1552**
 Authority

Company's Bank Details
 Bank Name: Canara Bank
 A/c No: 52513070000025
 Branch & IFS Code: Gandhibagh Branch & CNRB0015251
 for Maheshwari Trading Company 20-21

Declaration:
 We declare that this invoice shows the actual price of the goods described and that all particulars are true and correct.

Authorized Signatory

This is a Computer Generated Invoice

From the recommendation of the review committee please approve the following proposals with amount

Sr. No.			Amount Requested
1	Dr. U. S. Ghodeswar, EE Department	Wireless Communication using Zigbee	10,000/-
2	Dr. P. P. Zode, EE Department	Long Range Wireless Communication Setup	40,800/-
3	Prof. Atul Lihare, EL Department	Installation of automatic UPS system at Home (Demo Model)	11,700/-
			62,500/-

It is therefore requested to approve the above mentioned proposals under Innovative experimental set up scheme.

Dr. Yogita Chitriv,
Assistant Dean, Funding Proposal Vertical

Forwarded for approval

Through,

7/8/2021

Dr. Ujwala Gawande
Dean, R and D

Encl.

1. Approval of budget for In- house funding schemes

Forwarded to Principal Sir for kind approval

DK

07.08

Dean (RAD)

Yeshwantrao Chavan College of Engineering, Nagpur

FORM OF UTILIZATION CERTIFICATE

UTILIZATION CERTIFICATE FOR THE YEAR 2021-22 in respect of Non-recurring/Recurring for seed Money form the institute

1. Name of the Scheme : Innovative Experimental Setup
2. Title of the project: Wireless Communication Using Zigbee
3. Name of Principal Investigator: Dr. U. H. Ghodeswar
4. Name of Co-Principal Investigator (If Any):
5. Sanction Letter No.: YCCE/R and D Cell/2021-22/1011 Dt. 27/08/2021
6. Amount Sanctioned: Non recurring: 10,000/- Recurring: NIL
Total Amount Sanctioned: 10,000/-
7. Actual expenditure : Non Recurring: 10,000/- Recurring: NIL
Total Expenditure (Actual): 10,000/-

Certified that the amount of Rs. 10,000/- has been utilised under Innovative Experimental Set up scheme.

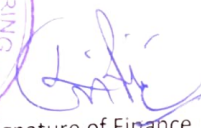

Signature of Finance Officer
Yeshwantrao Chavan College of Engineering
Wanadongri, Hingna Road
Nagpur-441110



Signature of Head of the Institute
Dr. U. P. Waghe, Principal
Yeshwantrao Chavan College of Engineering
Wanadongri, Hingna Road
Nagpur-441110



Principal
Yeshwantrao Chavan
College of Engineering
Wanadongri Hingna Road
NAGPUR-441110

Report

1. Name of the Scheme :In-House scheme of Innovative Experimental Research
2. Title of the project:Wireless communication using Zigbee.
3. Name of Principal Investigator:Dr.U.S.Ghodeswar
4. Name of Co-Principal Investigator (If Any):---
5. Sanction Letter No.:YCCE/R and D Cell/2021-22/1011
6. Details of Proposal :

(Introduction, Working Principal with Circuit Diagram/Block diagram, Results analysis with photographs and conclusion):

Components required: Digi XBee Zigbee Mesh Kit Components

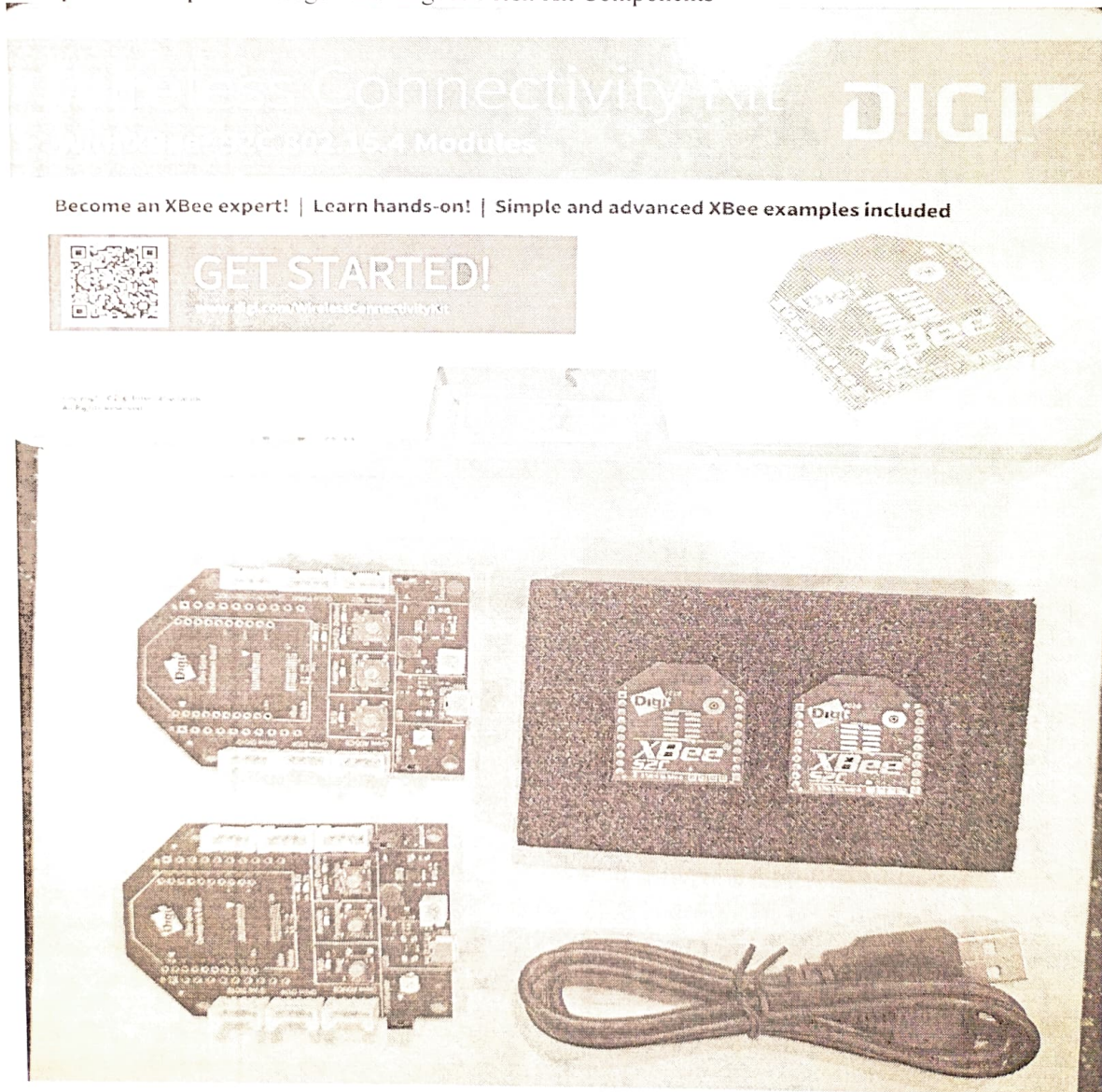

Figure1: Digi XBee Zigbee Mesh Kit Components

Hardware

Digi XBee RF modules are used for device connectivity and ZigBee-based mesh networking. Digi's XBee Mesh kit uses XBee modules which are small radio frequency (RF) devices to create mesh network that transmit and receive data over the air using ZigBee protocol, specifically designed for low-data rate and low-power applications. The device supports many applications such as remote-control, long-distance sensor monitoring, complex robotic, WAN, etc. The main advantage is low power consumption and simple developments.

Digi XBee products have variety of products and models, which differ in size, protocol, operating frequency, and performance. XBee is divided into RF modules and cellular modules. Table below shows the specifications of basic XBee models which use IEEE 802.15.4 ZigBee protocol.

Indoor Range	60m (200 ft)
Outdoor Range	1200m (4000 ft)
Transmit Power	+8 dBm
Transmit Current	40 mA
Supply Voltage	2.1 to 3.6 V

Table: specifications of basic XBee model

XBee Zigbee Mesh Kit Components

XBee Zigbee Mesh kit main components are shown in figure 1. The kit includes 2 Digi XBee Grove Development Boards, 2 Digi XBee 3 Zigbee SMT modules, 2 Micro-USB Cables

XBee Grove Development Board

XBee Grove Development Board is an easy simple base unit that allows user to evaluate XBee modules with PC or microcontroller. The grove development board can be powered by 5V supply using micro USB or external battery connected to the 2-pin battery pin. The board also provides a 3.3V regulator with 500mA. This development board has features such as several grove connectors and some push button.

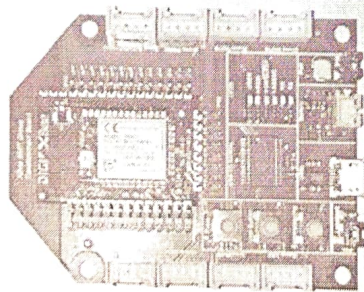

Figure: XBee module mount on grove development board

XBee ZigBee Surface Mount Module

XBee ZigBee SMT module is a low cost, low power, simple-to-use product that has 37 pads mounted directly to PCB without any pin holes. The ZigBee protocol has a frequency of 2.4GHz open global wireless standard with reliable communication through noisy RF environments. We can use it to evaluate XBee modules, as it connects any XBee/XBee-PRO module to a PC or microcontroller. One of the main features of the board is that it has several Grove connectors where you can plug in a Grove Module. The module provides 4 10-bit ADC inputs and 15 digital I/O pins. The sight of range for this module is 200ft (60m) indoor and 4000ft (1200m) outdoor. The RF data rate is 250 kbps. The current draw for transmit is 40 mA @ 8 dBm and 17mA for receive. Pinout of XBee ZigBee SMT module can be found in Appendix-B.

XBee Transmission Modes

XBee acts as RF device to communicate with other devices over air. Both devices must in the same network for successful transmission. XBee module support two operating modes, Transparent and Application Programming Interface (API) mode.

API mode provides the ability to perform more complex communication compared to transparent mode. It provides structured data communication by organizing packets into a frame. API mode can configure host or remote device through API frame, manage transmission to multiple remote device, status of transmit frame and request RSSI value of any received packet from any remote device. Figure below show that a coordinator is sending an AT command (0x17) request to read the remote device parameters, and the remote device is responding to AT command request (0x97) with the requested parameters.

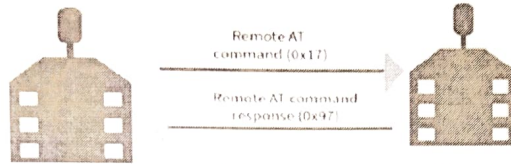

Figure: Request and Transmit through API mode

API Frame

In API mode, multiple packets information is structured together into an API frame. This frame is used to send and receive data through wireless communication. Some extra information added into API frame is start delimiter, checksum, destination and sources of the data. Start delimiter is the first byte of the frame to indicate start of the frame to make it easier to detect and separate between frames. Length shows the total number of bytes in the data frame. Data frame is the data information with source MAC address added. Check sum is the last byte in the frame to detect any error that occurs during transmission and reception.

Experimental setup:



Fig. Experimental setup

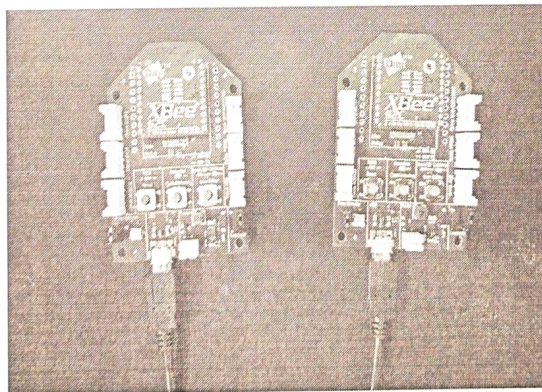
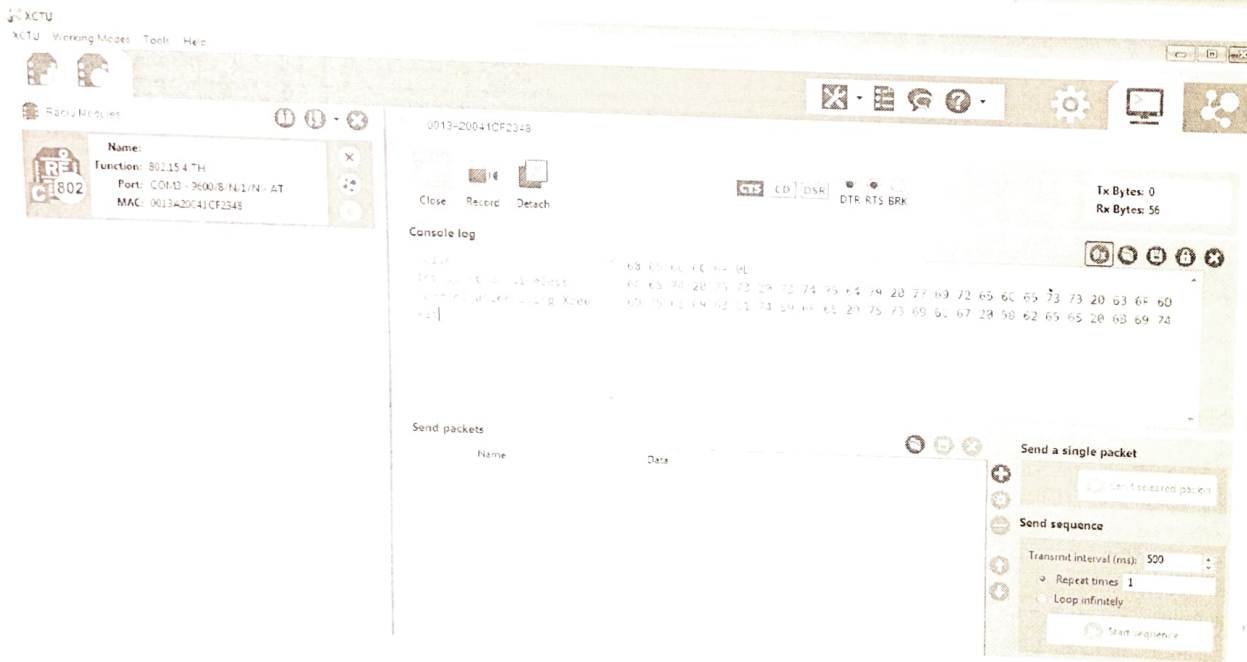
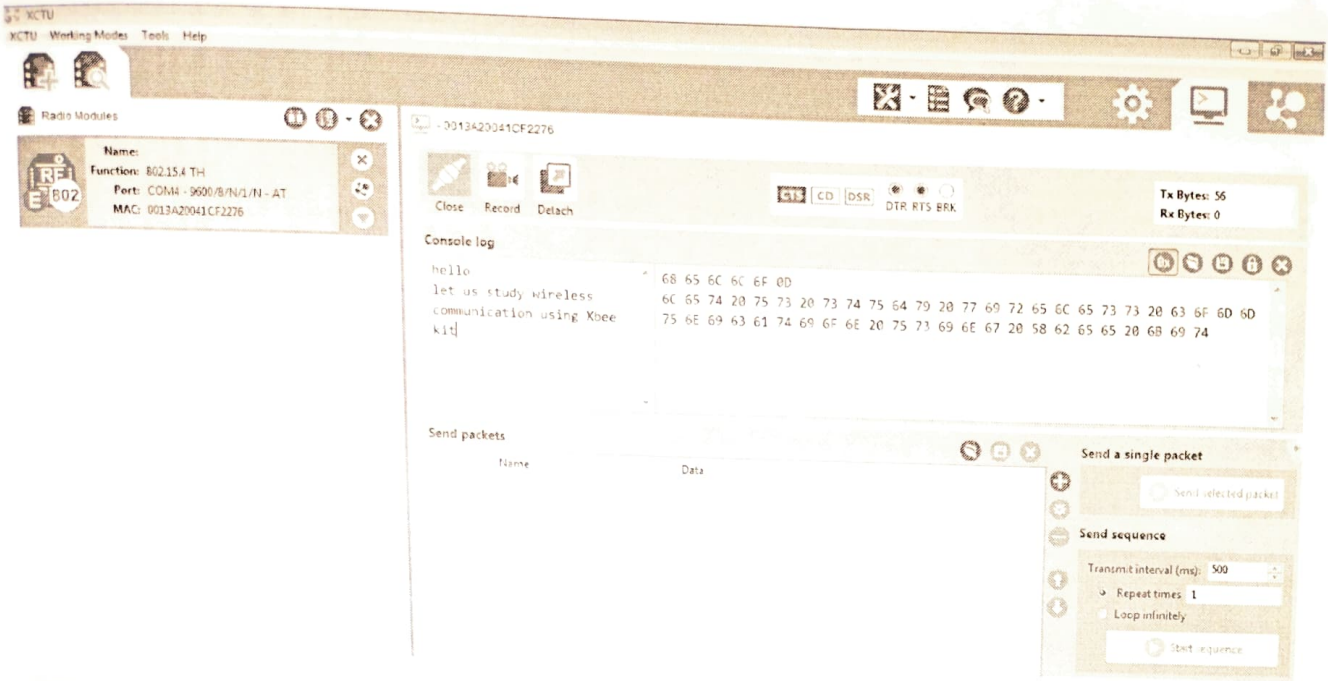

Fig. shows communication using Zigbee. This setup is required for observing real time communication using Zigbee.

Our experiments were conducted to evaluate a series of measurements. The signals are measured by requesting RSSI through remote AT command. Both devices are first connected to PC through USB cable for initial configuration to form a wireless network. The coordinator device stays directly connected to PC for easier adjustment by XBee Configuration Test Utility (XCTU). The remote device is disconnected from PC to the wall outlet with approximate 3 ft apart from coordinator.

Results: Com 4 and com 3 are two ports connected to two development boards.Both ports can communicate each other using XCTU software in console log. Communication Screen shots are given below.



Conclusion: wireless communication using Digi Xbee kit is studied.

7. Applications where the product/Setup used for:

Digi XBee is a wireless communication module that enables connectivity between machines, devices, towers, industrial tanks and oil wells, wastewater management systems, city lighting, agricultural irrigation systems, manufacturing robotics and more. These embedded devices can be found inside millions of applications worldwide that sends signals and data between sensors and gateways to the cloud or other edge devices to automate processes, provide remote connectivity and deliver insights from difficult-to-reach places.

Ashutoshgode
 A.S. Khosroogode

Pranav
 P.T. Ramde

Bhushan

HPB4838E1Z9
HPB4838E

॥ श्री गणेशाय नमः ॥
TAX INVOICE

Mob. 9158012235
8668549794

ROBO STUDIO

DEALS IN : ELECTRONIC COMPONENTS, DIY KITS, SOLAR PANEL & BATTERIES

STORE ADDRESS : IN FRONT OF POOJA LODGE, TELIPURA, ELECTRONICS MARKET, NAGPUR-440012.
Email : robostudionagpur@gmail.com, Website : www.robostudio.in

Invoice No 1056



Date 25/10/2021

M/s Yeshwantrao Chavan College of Engineering, Hingna, Nagpur

State Maharashtra State Code 27

PO No. YCC/POHO/21-22/114/545 Buyer's GSTIN No. -

Transport No. - G.R./R.R. No. - Date 25/10/2021

Sl	QTY	PARICULARS	HSN CODE	RATE	UOM	AMOUNT
01		Digi XBee Zigbee Mesh Kit	8538	9200=00	Pcs	9200=00
Certified that the items / Articles of Bill No. 1056 Dated 25/10/21 have been entered in the Stock on Page No. Date 25/10/21 Signature of Store Keeper						
Gate Entry Slip No. 25-10-21/61 Security duty supervisor Signature Nagpur			All certified for payment of Rs. 10313/- Signature - Authority			

AXIS BANK
A/c. No. 917020060783498
IFSC CODE : UTIB0000330

Customer Name :
Mobile No. :

PACKING & FREIGHT	-
Total Taxable Amount	9200=00
Add : CGST 9 @%	828=00
Add : SGST 9 @%	828=00
Add : IGST @%	
Total Amount with GST	10856=00

E. & E. O.
All Disputes Subject to Nagpur Jurisdiction.
Goods once sold cannot be taken back.
NO GUARANTEE NO WARRANTY

Customer's Signature 25/10/21
less Penalty 5%
- 543
10313/-
Auth. Signatory For ROBO STUDIO



Nagar Yuwak Shikshan Sanstha's

Yeshwantrao Chavan College of Engineering

(An Autonomous Institution affiliated to Rashtrasant Tukadoji Maharaj Nagpur University)

Hingna Road, Wanadongri, Nagpur - 441 110

NAAC Accredited with A⁺ Grade

Ph.: 07104-295083, 295085, Website: www.ycce.edu, Email: principal@ycce.edu

Declaration by Head of Institute

I hereby declared that the data, information and support documents attached herewith are genuine and correct to my knowledge.

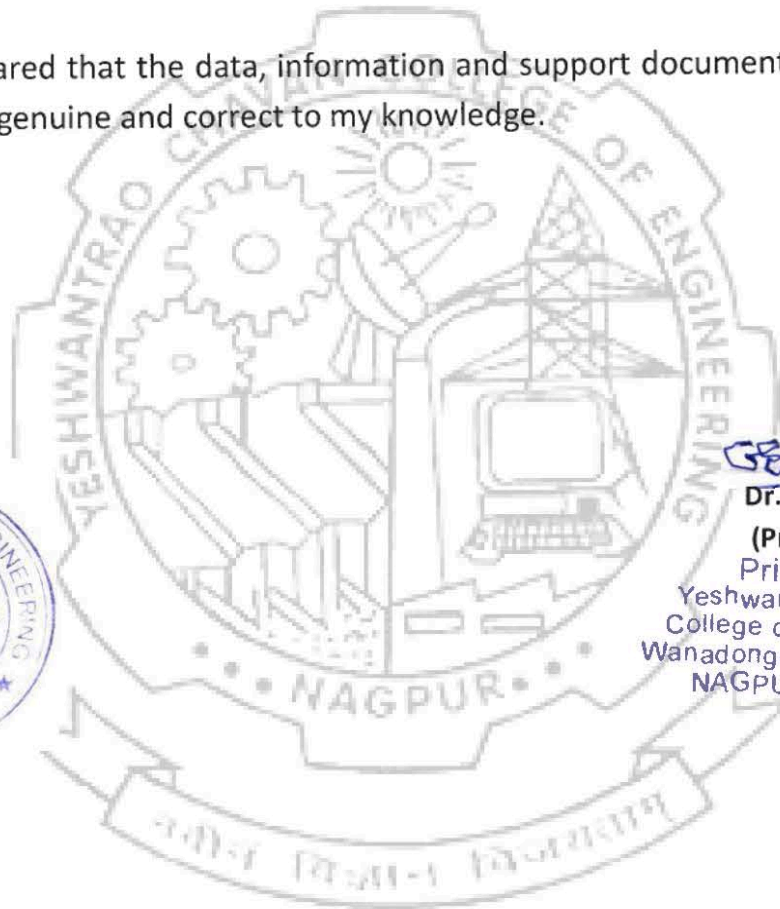

Dr. U. P. Waghe

(Principal)

Principal

Yeshwantrao Chavan
College of Engineering
Wanadongri Hingna Road
NAGPUR - 441110